

Auf den Punkt genau.

Positionieren und Messen mit Laser- und Optosensorik.

[engl.]

*Eagle-Eye Precision.
Pinpoint Positioning and
Measuring with Laser and
Optical Sensor Systems.*

Abstandsmessung
und Positionierung

[engl.]

*Distance Measuring
and Positioning*

L-LAS-TB-CL / L-LAS-LT-CL / L-LAS-RL-CL Serie

Zeilensensoren

Line Sensors

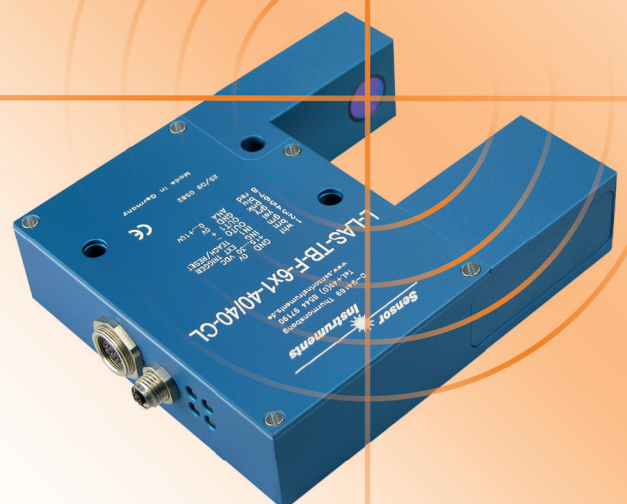

Vielfältige Einsatzmöglichkeiten der L-LAS-...-CL Zeilensensoren der „Compact Line“ Manifold fields of applications for L-LAS-...-CL line sensors of „Compact Line“

Zeilensensoren finden überall dort Einsatz, wo ein präzises Positionieren gefordert wird oder aber die Abmessung eines Objektes sehr genau ermittelt werden muss (z.B. der Durchmesser eines Drahtes, gemessen mit einem L-LAS-TB-F-... System).

Line sensors are applied where precise positioning is required or where the dimensions of an object have to be determined with high accuracy (e.g. diameter of a wire measured with an L-LAS-TB-F-... system).

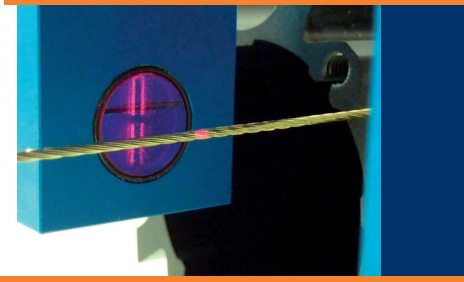

Laser-Durchlicht-Zeilensensoren der L-LAS-TB-...-CL Serie Laser transmitted light line sensors of L-LAS-TB-...-CL series

In der L-LAS-TB-...-CL Serie stehen verschiedene Arbeitsbreiten mit einer Auflösung von bis zu 2048 Pixel (16384 Subpixel) zur Auswahl. Ein Analogausgang (Spannungsausgang und optionaler Stromausgang) informiert dabei über die Position bzw. Größe des Objektes. Desweiteren steht ein Digitalsignal zur Verfügung, das über die Qualität bzw. die Position des Objektes informiert.

The L-LAS-TB-...-CL sensors offer various operating widths with a resolution of 2048 pixels (16384 subpixels). An analog output (voltage output and optionally current output) informs about position and size of the object. Furthermore, a digital output is available that informs about quality and position of the object.



Laser-Triangulations-Zeilensensoren der L-LAS-LT-...-CL Serie Laser distance line sensors of L-LAS-LT-...-CL series

Mit den Laser-Triangulationssensoren der L-LAS-LT-...-CL Serie können Abstand bzw. Dicke von Objekten sehr genau bestimmt werden (Auflösung ab typ. 2 µm). Für hochglänzende Objekte (z.B. Glas) ist die Sonderversion L-LAS-LT-85-RA-CL verfügbar und für große Messbereiche bis zu 715 mm bieten wir die Sonderversion L-LAS-LT-157-CL an.

The laser distance sensors of the L-LAS-LT-...-CL series determine the distance or thickness of objects with highest accuracy (resolution starting from typ. 2 µm). For high-gloss objects (e.g. glass) the special version L-LAS-LT-85-RA-CL is available and for big measuring ranges up to 715 mm we offer the special version L-LAS-LT-157-CL.



Reflexlicht-Zeilensensoren der L-LAS-RL-...-CL Serie Reflected light line sensors of L-LAS-RL-...-CL series

Die Reflexlicht-Zeilensensoren der L-LAS-RL-...-CL Serie dienen der Ermittlung der Position bzw. Breite des Messobjekts im Reflexbetrieb. Es können Messbereiche von 10 mm (bei einem Arbeitsabstand von 33 mm mit dem L-LAS-RL-10-...-CL) bis 40 mm (bei einem Arbeitsabstand von 100 mm mit dem L-LAS-RL-40-...-CL) abgedeckt werden.

The reflected light line sensors of the L-LAS-RL-...-CL series are used for the detection of position or width of the measuring object in reflected light operation. They can cover measuring ranges from 10 mm (at an operating distance of 33 mm with L-LAS-RL-10-...-CL) up to a measuring range of 40 mm (at a reference distance of 100 mm with L-LAS-RL-40-...-CL).



Windows® PC Software L-LAS-TB-Scope, L-LAS-LT-Scope, L-LAS-RL-Scope Windows® PC software L-LAS-TB-Scope, L-LAS-LT-Scope, L-LAS-RL-Scope

Mit Hilfe der Windows®-Bedienoberfläche können die L-LAS Zeilensensoren sehr einfach parametrisiert werden. Folgende Einstellungen können mit Hilfe der L-LAS-TB-Scope Software am Sensor vorgenommen werden: Einstellung der Laserleistung bzw. Lichtleistung und Art der Leistungsnachregelung, Polarität der Digitalausgänge, verschiedene Auswertemodi, Auslösen des Teachvorgangs durch Softwaretaste, Einstellung der Toleranzgrenzen für die Überwachung des Messwertes. Desweiteren können mit Hilfe der Software verschiedene numerische und graphische Messgrößen visualisiert werden. So können die Rohdaten des CCD-Zeilensensors graphisch und numerisch dargestellt werden.

The L-LAS line sensors can be easily parameterised with the Windows® user interface. With the help of the L-LAS-TB-Scope software the following settings can be made at the sensor: Setting of laser power or light power and type of automatic power correction, polarity of digital outputs, different evaluation modes, start of the teach process by software button, setting of tolerance ranges for monitoring the measured value. Furthermore, various numerical and graphical measured quantities can be visualized with the L-LAS-TB-Scope software. For example, the raw data of the CCD line sensor can be displayed graphically and numerically.

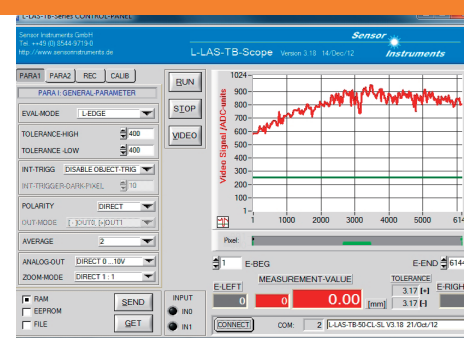

Applikationsbeispiel:
Application example:

Erkennung von falschem Durchmesser an Kabel-Schirmgeflechten
Braided cable sleeves diameter failure detection

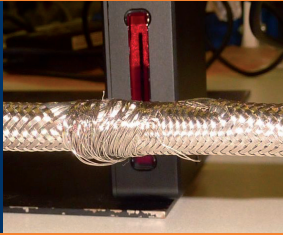

Es sollen Durchmesserabweichungen von Schirmgeflechten erkannt werden. Dazu wird ein Laser-Zeilensensor vom Typ L-LAS-TB-28-T-CL (Sender) und L-LAS-TB-28-R-CL (Empfänger) verwendet. Der Sender-/Empfängerabstand beträgt ca. 100 mm, der Messbereich ca. 28 mm.

Deviations of the diameter of braided sleeves should be detected. For this purpose a laser line scan sensor type L-LAS-TB-28-T-CL (transmitter) and L-LAS-TB-28-R-CL (receiver) is used. The distance of transmitter and receiver is approximately 100 mm and the detecting range is around 28 mm.

Applikationsbeispiel:
Application example:

Durchmessermessung und Positionskontrolle von Glasstäben
Diameter measurement and position control of glass rods

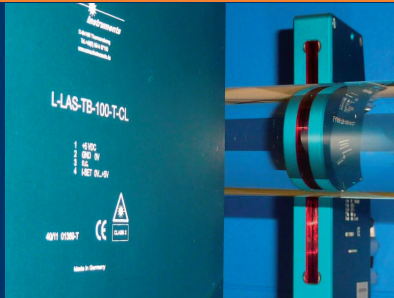

Es soll sowohl der Durchmesser als auch die Position von Glasstäben, dem Ausgangsprodukt für Lichtleiter, gemessen werden. Für diese Anwendung wird ein Laser-Durchlichtsensor vom Typ L-LAS-TB-100-T-CL (Sender) und L-LAS-TB-100-R-CL (Empfänger) verwendet. Damit können sowohl der Durchmesser als auch die senkrechte Position der Achse des Glasstabes gleichzeitig gemessen werden. Dabei kann das Sensoreingangssignal zum Umschalten des Analogausgangssignals von Durchmessermessung auf Positionsmessung benutzt werden.

The diameter as well as the position of glass rods, the starting product of optical fibers, should be measured. For this purpose a laser through beam sensor type L-LAS-TB-100-T-CL (transmitter) and L-LAS-TB-100-R-CL (receiver) is used. The diameter as well as the perpendicular position of the axis of the glass rod can be measured simultaneously. At this the sensor input signal can be used to switch the analog output signal from diameter measurement to position measurement.

Applikationsbeispiel:
Application example:

Doppelblechkontrolle
Double sheet control

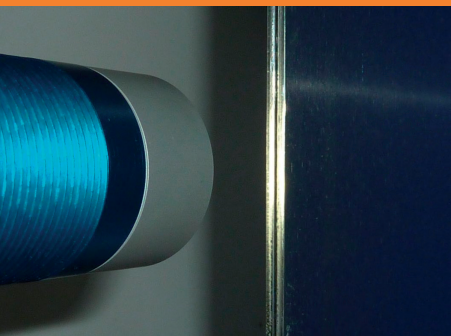

Mit einem Roboter sollen Blechplatten von einem Stapel entnommen werden. Der Roboter saugt die Blechplatten einzeln an, und es soll aus Sicherheitsgründen vermieden werden, dass gleichzeitig zwei Blechplatten bewegt werden. Ein Sensor soll doppelte Bleche nicht von oben, sondern von der Seite erkennen. Außerdem soll das System nach einem Wechsel des Blechtyps (andere Dicke oder anderes Metall) automatisch angepasst werden. Es wird hierfür ein Reflexlicht-Zeilensensor vom Typ L-LAS-RL-20-W verwendet (bzw. gleichwertiger Typ L-LAS-RL-20-W-CL aus der Compact Line).

Metal plates should be removed from a stack with a robot. The robot sucks the metal sheets one by one and it should be avoided for safety reasons to move two metal sheets simultaneously. A sensor should detect double sheet not from the top but from the side. Furthermore, the system should be adapted automatically after a change of the type of metal sheet (different thickness or different metal). At this a reflective line scan detector type L-LAS-RL-20-W is used (or equivalent type L-LAS-RL-20-W-CL of the Compact Line).

Applikationsbeispiel:
Application example:

Abstandsmessung an transparenten Glasscheiben
Distance measurement on transparent glass plates

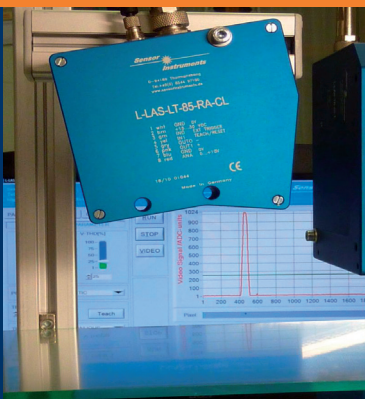

Beim Handling von Glasscheiben muss der Abstand der Glasoberfläche kontrolliert werden. Zum Abschrägen muss die Glasscheibe so positioniert werden, dass die Glaskanten symmetrisch in den Schleifblock der Schleifmaschine eingeführt werden können, da sonst die Abschrägungen an beiden Seiten der Glasscheibe unterschiedlich wären. Da die Glasoberfläche fast kein diffus reflektiertes Licht liefert, sondern nur direkt reflektiertes Licht, kann kein Standard-Laserabstandssensor verwendet werden. Der Laser-Abstandssensor L-LAS-LT-85-RA-CL ist jedoch speziell ausgerüstet für Direktreflektionsmessungen auf transparenten Objekten. Um ein korrektes Ergebnis zu erzielen muss das reflektierte Laserlicht von der Glasscheibe auf die Empfängeroptik des Lasersensors auftreffen, d.h. der Lasersensor muss geneigt werden.

During the handling process of glass plates the distance of the glass surface must be controlled. As during the beveling process the glass plate must be positioned in a way that the glass edges can be feed symmetrically into the abrasive block of the grinding machine, otherwise the phases on both sides of the glass plate are different. Due to the fact, that the glass surface delivers nearly no diffuse reflected light but only direct reflected light, a standard laser displacement sensor cannot be used. The laser displacement sensor L-LAS-LT-85-RA-CL, however, is especially prepared for measuring on transparent objects in the direct reflective way. To get a proper result, the reflected laser light from the glass plate must strike the receiver optics of the laser sensor, which means that the laser sensor must be tilted.

Applikationsbeispiel:
Application example:

Seitliche Positionskontrolle von Förderbändern in der Holz- und Papierindustrie
Lateral position control of conveyor belts in the wood and paper industry

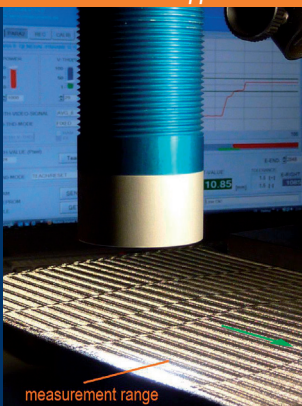

In der Holzindustrie (z.B. bei der Herstellung von MDF-Platten) und in der Papierindustrie kommen spezielle Förderbänder zum Einsatz. Die seitliche Position des Bandmaterials muss in einem Bereich von $\pm 0,2$ mm gehalten werden, während die vertikale Position im Bereich von ± 2 mm variieren kann. Das Förderband besteht entweder aus Edelstahl oder aus Kunststoffgewebe. Bei vielen Einbausituationen ist der Einsatz eines Durchlichtsystems wie aus der L-LAS-TB Serie nicht möglich, es wird daher ein Reflexlicht-Zeilensensor benutzt. In diesem Fall ist das Modell L-LAS-RL-20-W eine angemessene Lösung. Der Sensor ist mit einem M34 Gewindegehäuse, oder als Typ L-LAS-RL-20-W-CL (Compact Line) mit rechteckigem Gehäuse erhältlich.

In the wood industry (during the production e.g. of MDFs = medium density fiber boards) as well as in the paper industry, special conveyor belts are in use. The lateral position of the band material must be hold in a range of ± 0.2 mm, whereas the vertical position can change in the range of ± 2 mm. The material of the conveyor belt is either stainless steel or plastic fabric. In many installation situations in practice, it is not possible to use a through beam system like the L-LAS-TB series, thus the reflected light line sensor. Here, the L-LAS-RL-20-W is the practical solution. The sensor is available in a M34 thread housing or in a rectangular housing type L-LAS-RL-20-W-CL (Compact Line).

L-LAS-TB-...-CL

Laser-Durchlicht-Zeilensensoren „Compact Line“

Laser transmitted light line sensors „Compact Line“

TYP	LICHT-QUELLE	ARBEITS-ABSTAND	MESSBEREICH (TYP.)	AUFLÖSUNG (TYP.)	REPRODUZIERBARKEIT (TYP.)	CCD-ZEILEN-DETEKTOR	LINEARITÄT (TYP.)	MAX. SCAN-FREQUENZ	ABMESSUNGEN (CA.)	DIGITALE EIN-/AUSGÄNGE	ANALOGUE AUSGÄNGE	SOFTWARE/SCHNITTSTELLE				
TYPE	LIGHT SOURCE	WORKING DISTANCE	MEASURING RANGE (TYP.)	RESOLUTION (TYP.)	REPRODUCIBILITY (TYP.)	CCD LINE DETECTOR	LINEARITY (TYP.)	MAX. SCAN FREQUENCY	DIMENSIONS (APPROX.)	DIGITAL INPUTS/OUTPUTS	ANALOG OUTPUTS	SOFTWARE/INTERFACE				
Geteilte Versionen Split versions T=Sender Transmitter, R=Empfänger Receiver																
L-LAS-TB-6-T-CL L-LAS-TB-6-R-CL L-LAS-TB-6-R-4/20-CL	Linienlaser, 670 nm, <0.4 mW, Laser- klasse 1	Max. 2000 mm	6.4 mm	2 µm	±2 µm	512 Pixel, 4096 Subpixel	0.2% FSR	800 Hz	T: 80x65x24 mm R: 80x40x24 mm	2x Digitaleingang: INO, IN1 (0/+24 V) 2x Digitalausgang: OUT0, OUT1 (0/+24 V), npn-/pnp-fähig	1x Analog- ausgang: 0...+10 V Bei Typ -4/20-CL: 2x Analog- ausgang: 0...+10 V 4...20 mA	L-LAS-TB-Scope/ RS232 (USB- und Ethernet- Adapter erhältlich)				
L-LAS-TB-16x1-T-CL L-LAS-TB-16x1-R-CL L-LAS-TB-16x1-R-4/20-CL		Max. 2000 mm	16 mm	8 µm	±8 µm	256 Pixel, 2048 Subpixel	0.2% FSR	2 kHz	T: 80x70x24 mm R: 80x70x24 mm							
L-LAS-TB-1x16-T-CL L-LAS-TB-1x16-R-CL L-LAS-TB-1x16-R-4/20-CL		Max. 2000 mm	16 mm	8 µm	±8 µm	256 Pixel, 2048 Subpixel	0.2% FSR	2 kHz	T: 80x70x24 mm R: 80x70x24 mm							
L-LAS-TB-28-T-CL L-LAS-TB-28-R-CL L-LAS-TB-28-R-4/20-CL		Max. 2000 mm	28 mm	2 µm	±2 µm	2048 Pixel, 16384 Subpixel	0.08% FSR	200 Hz	T: 100x98x20 mm R: 70x98x20 mm							
L-LAS-TB-50-T-CL L-LAS-TB-50-R-CL L-LAS-TB-50-R-4/20-CL		Max. 2000 mm	48 mm	8 µm	±8 µm	768 Pixel, 6144 Subpixel	0.1% FSR	1 kHz	T: 125x98x20 mm R: 70x98x20 mm							
L-LAS-TB-75-T-CL L-LAS-TB-75-R-CL L-LAS-TB-75-R-4/20-CL		Max. 2000 mm	73 mm	8 µm	±8 µm	1152 Pixel, 9216 Subpixel	0.06% FSR	600 Hz	T: 130x118x20 mm R: 70x118x20 mm							
L-LAS-TB-100-T-CL L-LAS-TB-100-R-CL L-LAS-TB-100-R-4/20-CL		Max. 2000 mm	98 mm	8 µm	±8 µm	1536 Pixel, 12288 Subpixel	0.05% FSR	450 Hz	T: 170x143x20 mm R: 70x143x20 mm							
Gabelversionen Fork versions																
L-LAS-TB-F-6x1-40/40-CL L-LAS-TB-F-6x1-40/40-4/20-CL		Line laser, 670 nm, <0.4 mW, class 1 laser product	40 mm	6.4 mm	2 µm	±2 µm	512 Pixel, 4096 Subpixel	0.1% FSR	800 Hz				100x85x24 mm	2x digital input: INO, IN1 (0/+24 V) 2x digital output: OUT0, OUT1 (0/+24 V), npn-/pnp-able	1x analog output: 0...+10 V In case of type -4/20-CL: 2x analog output: 0...+10 V 4...20 mA	L-LAS-TB-Scope/ RS232 (USB- and Ethernet adaptor available)
L-LAS-TB-F-1x6-40/40-CL L-LAS-TB-F-1x6-40/40-4/20-CL			40 mm	6.4 mm	2 µm	±2 µm	512 Pixel, 4096 Subpixel	0.1% FSR	800 Hz				100x85x24 mm			
L-LAS-TB-F-16x1-40/40-CL L-LAS-TB-F-16x1-40/40-4/20-CL	40 mm		16 mm	8 µm	±8 µm	256 Pixel, 2048 Subpixel	0.1% FSR	2 kHz	100x90x24 mm							
L-LAS-TB-F-1x16-40/40-CL L-LAS-TB-F-1x16-40/40-4/20-CL	40 mm		16 mm	8 µm	±8 µm	256 Pixel, 2048 Subpixel	0.1% FSR	2 kHz	100x90x24 mm							
L-LAS-TB-F-6x1-100/100-CL L-LAS-TB-F-6x1-100/100-4/20-CL	100 mm		6.4 mm	2 µm	±2 µm	512 Pixel, 4096 Subpixel	0.1% FSR	800 Hz	160x150x24 mm							
L-LAS-TB-F-1x6-100/100-CL L-LAS-TB-F-1x6-100/100-4/20-CL	100 mm		6.4 mm	2 µm	±2 µm	512 Pixel, 4096 Subpixel	0.1% FSR	800 Hz	160x150x24 mm							
L-LAS-TB-F-16x1-100/100-CL L-LAS-TB-F-16x1-100/100-4/20-CL	100 mm		16 mm	8 µm	±8 µm	256 Pixel, 2048 Subpixel	0.1% FSR	2 kHz	160x150x24 mm							
L-LAS-TB-F-1x16-100/100-CL L-LAS-TB-F-1x16-100/100-4/20-CL	100 mm		16 mm	8 µm	±8 µm	256 Pixel, 2048 Subpixel	0.1% FSR	2 kHz	160x150x24 mm							
Sonderversion Special version																
L-LAS-TB-F-6x1-20/40-CL			20 mm	5.6 mm	2 µm	±2 µm	448 Pixel, 3584 Subpixel	0.2% FSR	800 Hz	115x60x12 mm						
ALLGEMEINE TECHNISCHE DATEN	Spannungsversorgung: +24VDC (± 10%). Stromverbrauch: <200 mA. Schutzart: IP64. Gehäusematerial: Aluminium schwarz eloxiert. LED-Anzeigen: 2x rot/grün, 2x gelb/grün. Max. Schaltstrom: 100 mA, kurzschlussfest. Betriebstemperaturbereich: -10°C...+50°C. EMV-Test nach: DIN EN 60947-2															
GENERAL TECHNICAL DATA	Voltage supply: +24VDC (± 10%). Current consumption: <200 mA. Enclosure rating: IP64. Housing material: Aluminum anodized in black. LED display: 2x red/green, 2x yellow/green. Max. switching current: 100 mA, short circuit proof. Operating temperature range: -10°C...+50°C. EMC test acc. to: DIN EN 60947-2.															

Abbildungen | Illustrations

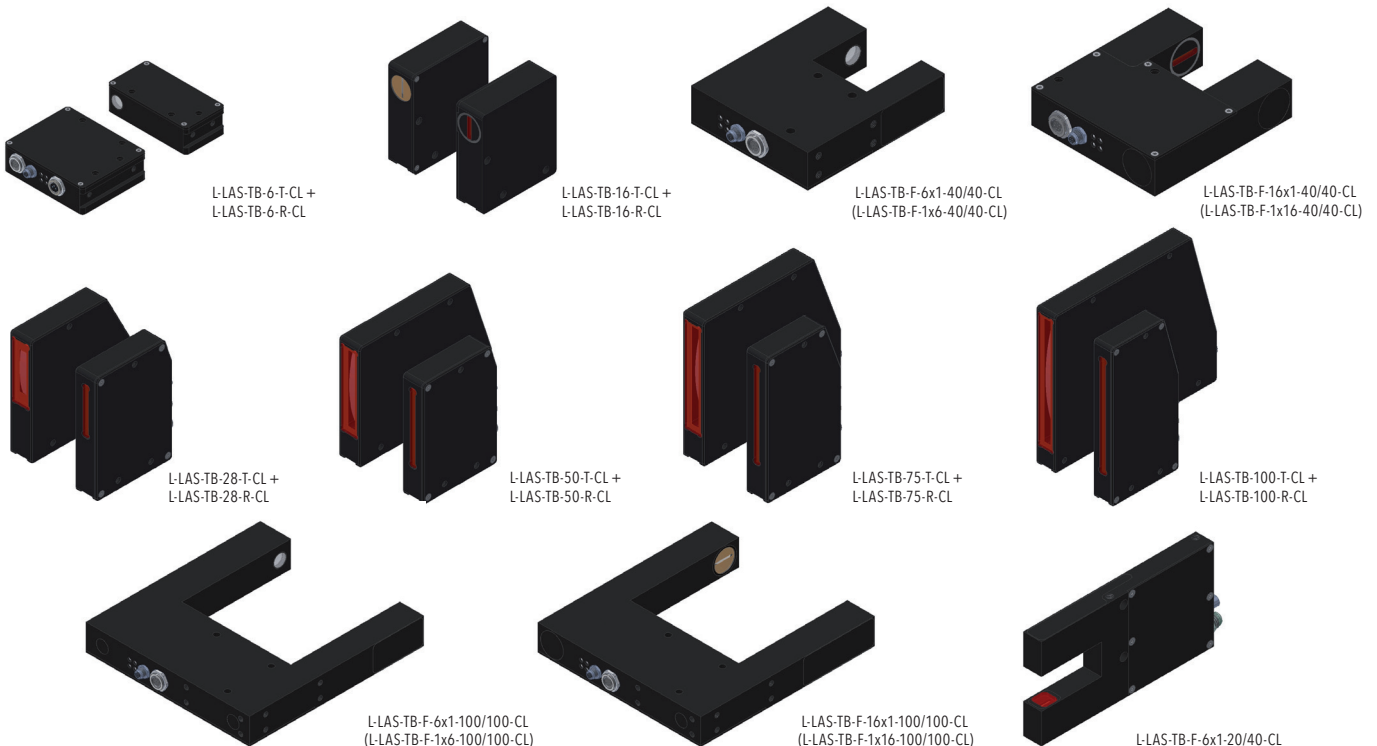

L-LAS-LT-...-CL

Laser-Triangulations-Zeilensensoren „Compact Line“

Laser distance line sensors „Compact Line“

TYP	LICHTQUELLE	MESSBEREICH (VON ... BIS, TYP.)	AUFLÖSUNG (TYP.)	REPRODUZIER- BARKEIT (TYP.)	LASERLINIEN- GEOMETRIE (TYP.)	LINEARITÄT (TYP.)	MAX. SCAN- FREQUENZ	ABMESSUNGEN (CA.)	DIGITALE EIN-/ AUSGÄNGE	ANALOGUE AUSGÄNGE	SOFTWARE/ SCHNITTSTELLE			
TYPE	LIGHT SOURCE	MEASURING RANGE (FROM ... TO, TYP.)	RESOLUTION (TYP.)	REPRODUCI- BILITY (TYP.)	LASER LINE GEOMETRY (TYP.)	LINEARITY (TYP.)	MAX. SCAN FREQUENCY	DIMENSIONS (APPROX.)	DIGITAL INPUTS/ OUTPUTS	ANALOG OUTPUTS	SOFTWARE/ INTERFACE			
L-LAS-LT-20-CL L-LAS-LT-20-CL-4/20	Linienlaser, 670 nm, <1 mW, Laserklasse 2	3.5 mm (18.5 ... 22 mm)	2 µm	±2 µm	0.3 x 3 mm	0.2% FSR	500 Hz	82.26x80x20 mm	2x Digitaleingang: INO, IN1 (0/+24 V) 2x Digitalausgang: OUT0, OUT1 (0/+24 V), npn-/pnp-fähig	1x Analogausgang: 0...+10 V Bei Typ -4/20-CL: 2x Analogausgang: 0...+10 V 4...20 mA	L-LAS-LT-Scope/ RS232 (USB- und Ethernet- Adapter erhältlich)			
L-LAS-LT-38-CL L-LAS-LT-38-CL-4/20		20 mm (30 ... 50 mm)	10 µm	±10 µm	0.3 x 3 mm	0.2% FSR	500 Hz	81.19x65x20 mm						
L-LAS-LT-50-CL L-LAS-LT-50-CL-4/20		40 mm (35 ... 75 mm)	20 µm	±20 µm	0.3 x 3 mm	0.25% FSR	500 Hz	82.85x60x20 mm						
L-LAS-LT-120-CL L-LAS-LT-120-CL-4/20		120 mm (60 ... 180 mm)	60 µm	±60 µm	0.3 x 3 mm	0.25% FSR	500 Hz	75.59x65x20 mm						
L-LAS-LT-165-CL L-LAS-LT-165-CL-4/20		200 mm (75 ... 275 mm)	0.1 mm	±0.1 mm	0.5 x 3 mm	0.3% FSR	500 Hz	74.82x65x20 mm						
L-LAS-LT-250-CL L-LAS-LT-250-CL-4/20		450 mm (50 ... 500 m)	0.25 mm	±0.25 mm	2 x 3 mm	0.5% FSR	500 Hz	71.25x60x20 mm						
Sonderversionen <i>Special versions</i>												2x digital input: INO, IN1 (0/+24 V)	1x analog output: 0...+10 V	L-LAS-LT-Scope/ RS232 (USB- and Ethernet adaptor available)
L-LAS-LT-85-RA-CL L-LAS-LT-85-RA-CL-4/20		40 mm (70 ... 110 mm)	25 µm	±25 µm	0.3 x 3 mm	0.6% FSR	500 Hz	82.7x85x25 mm				2x digital output: OUT0, OUT1 (0/+24 V), npn-/pnp-able	In case of type -4/20-CL: 2x analog output: 0...+10 V 4...20 mA	
L-LAS-LT-157-CL L-LAS-LT-157-CL-4/20		715 mm (35 ... 750 mm)	0.4 mm	±0.4 mm	2 x 3 mm	0.6% FSR	500 Hz	71.25x60x20 mm						
ALLGEMEINE TECHNISCHE DATEN	Spannungsversorgung: +24VDC (± 10%). Stromverbrauch: <200 mA. Schutzart: IP64. Gehäusematerial: Aluminium schwarz eloxiert. LED-Anzeigen: 2x rot/grün, 2x gelb/grün. Max. Schaltstrom: 100 mA, kurzschlussfest. Betriebstemperaturbereich: -10°C...+50°C. EMV-Test nach: DIN EN 60947-2													
GENERAL TECHNICAL DATA	Voltage supply: +24VDC (± 10%). Current consumption: <200 mA. Enclosure rating: IP64. Housing material: Aluminum anodized in black. LED display: 2x red/green, 2x yellow/green. Max. switching current: 100 mA, short circuit proof. Operating temperature range: -10°C...+50°C. EMC test acc. to: DIN EN 60947-2.													

Abbildungen | Illustrations



L-LAS-LT-20-CL



L-LAS-LT-38-CL



L-LAS-LT-50-CL



L-LAS-LT-120-CL



L-LAS-LT-165-CL



L-LAS-LT-250-CL



L-LAS-LT-85-RA-CL



L-LAS-LT-157-CL

L-LAS-RL-...-CL

Reflexlicht-Zeilensensoren „Compact Line“

Reflected light line sensors „Compact Line“

TYP	LICHTQUELLE	REFERENZ-ABSTAND (TYP.)	ARBEITS-ABSTAND (TYP.)	MESSBEREICH (TYP.)	AUFLÖSUNG (TYP.)	REPRODUZIERBARKEIT (TYP.)	MIN. ERKENNB. OBJEKT (TYP.)	MAX. SCAN-FREQUENZ	ABMESSUNGEN (CA.)	DIGITALE EIN-/AUSGÄNGE	ANALOGUE AUSGÄNGE
TYPE	LIGHT SOURCE	REFERENCE DISTANCE (TYP.)	WORKING DISTANCE (TYP.)	MEASURING RANGE (TYP.)	RESOLUTION (TYP.)	REPRODUCIBILITY (TYP.)	MIN. DETECT. OBJECT (TYP.)	MAX. SCAN FREQUENCY	DIMENSIONS (APPROX.)	DIGITAL INPUTS/OUTPUTS	ANALOG OUTPUTS
L-LAS-RL-10-W-CL	9x Weißlicht-LED White-light LED	33 mm	33 mm ± 3 mm	10 mm	10 µm	±30 µm	0.1 mm	750 Hz	65 x 65 x 49.3 mm	2x Digitaleingang: IN0, IN1 (0/+24 V) 3x Digitalausgang: OUT0...OUT2 (0/+24 V), npn-/pnp-fähig 2x digital input: IN0, IN1 (0/+24 V) 3x digital output: OUT0...OUT2 (0/+24 V), npn-/pnp-able 1x Analogausgang: 0...+10 V oder 4...20 mA 1x analog output: 0...+10 V or 4...20 mA	
L-LAS-RL-20-W-CL		55 mm	55 mm ± 5 mm	20 mm	20 µm	±60 µm	0.1 mm	750 Hz	65 x 65 x 45.3 mm		
L-LAS-RL-30-W-CL		75 mm	75 mm ± 5 mm	30 mm	30 µm	±90 µm	0.15 mm	750 Hz	65 x 65 x 45.3 mm		
L-LAS-RL-40-W-CL		100 mm	100 mm ± 10 mm	40 mm	40 µm	±0.12mm	0.2 mm	750 Hz	65 x 65 x 45.3 mm		
L-LAS-RL-10-R-CL	9x Rotlicht-LED Red-light LED	33 mm	33 mm ± 3 mm	10 mm	10 µm	±30 µm	0.1 mm	750 Hz	65 x 65 x 49.3 mm		
L-LAS-RL-20-R-CL		55 mm	55 mm ± 5 mm	20 mm	20 µm	±60 µm	0.1 mm	750 Hz	65 x 65 x 45.3 mm		
L-LAS-RL-30-R-CL		75 mm	75 mm ± 5 mm	30 mm	30 µm	±90 µm	0.15 mm	750 Hz	65 x 65 x 45.3 mm		
L-LAS-RL-40-R-CL		100 mm	100 mm ± 10 mm	40 mm	40 µm	±0.12mm	0.2 mm	750 Hz	65 x 65 x 45.3 mm		
L-LAS-RL-10-B-CL	9x Blaulicht-LED Blue-light LED	33 mm	33 mm ± 3 mm	10 mm	10 µm	±30 µm	0.1 mm	750 Hz	65 x 65 x 49.3 mm		
L-LAS-RL-20-B-CL		55 mm	55 mm ± 5 mm	20 mm	20 µm	±60 µm	0.1 mm	750 Hz	65 x 65 x 45.3 mm		
L-LAS-RL-30-B-CL		75 mm	75 mm ± 5 mm	30 mm	30 µm	±90 µm	0.15 mm	750 Hz	65 x 65 x 45.3 mm		
L-LAS-RL-40-B-CL		100 mm	100 mm ± 10 mm	40 mm	40 µm	±0.12mm	0.2 mm	750 Hz	65 x 65 x 45.3 mm		
L-LAS-RL-10-UV-CL	9x UV-LED UV LED	33 mm	33 mm ± 3 mm	10 mm	10 µm	±30 µm	0.1 mm	750 Hz	65 x 65 x 49.3 mm		
L-LAS-RL-20-UV-CL		55 mm	55 mm ± 5 mm	20 mm	20 µm	±60 µm	0.1 mm	750 Hz	65 x 65 x 45.3 mm		
L-LAS-RL-30-UV-CL		75 mm	75 mm ± 5 mm	30 mm	30 µm	±90 µm	0.15 mm	750 Hz	65 x 65 x 45.3 mm		
L-LAS-RL-40-UV-CL		100 mm	100 mm ± 10 mm	40 mm	40 µm	±0.12mm	0.2 mm	750 Hz	65 x 65 x 45.3 mm		
ALLGEMEINE TECHNISCHE DATEN	Spannungsversorgung: +24VDC (± 10%). Stromverbrauch: <200 mA. Schutzart: IP64. Gehäusematerial: Aluminium schwarz eloxiert. LED-Anzeigen: 2x rot/grün, 2x gelb/grün. Max. Schaltstrom: 100 mA, kurzschlussfest. Betriebstemperaturbereich: -10°C...+50°C. EMV-Test nach: DIN EN 60947-2										
GENERAL TECHNICAL DATA	Voltage supply: +24VDC (± 10%). Current consumption: <200 mA. Enclosure rating: IP64. Housing material: Aluminum anodized in black. LED display: 2x red/green, 2x yellow/green. Max. switching current: 100 mA, short circuit proof. Operating temperature range: -10°C...+50°C. EMC test acc. to: DIN EN 60947-2.										

Abbildungen | Illustrations

Abmessungen in mm | Dimensions in mm

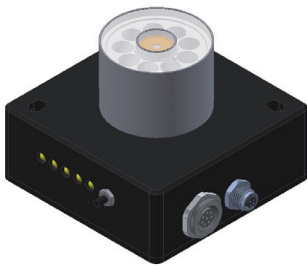

L-LAS-RL-10-W-CL
L-LAS-RL-10-R-CL
L-LAS-RL-10-B-CL
L-LAS-RL-10-UV-CL

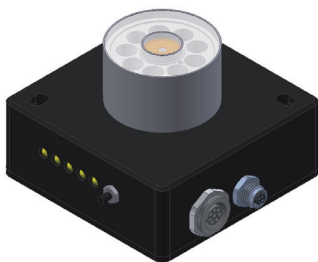
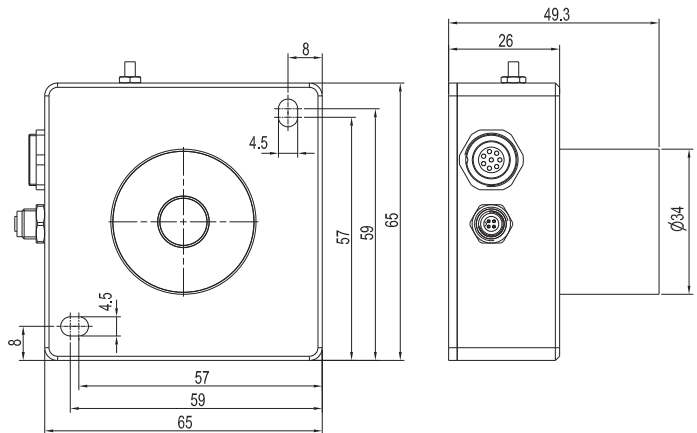

L-LAS-RL-20-W-CL
L-LAS-RL-20-R-CL
L-LAS-RL-20-B-CL
L-LAS-RL-20-UV-CL

L-LAS-RL-30-W-CL
L-LAS-RL-30-R-CL
L-LAS-RL-30-B-CL
L-LAS-RL-30-UV-CL

L-LAS-RL-40-W-CL
L-LAS-RL-40-R-CL
L-LAS-RL-40-B-CL
L-LAS-RL-40-UV-CL

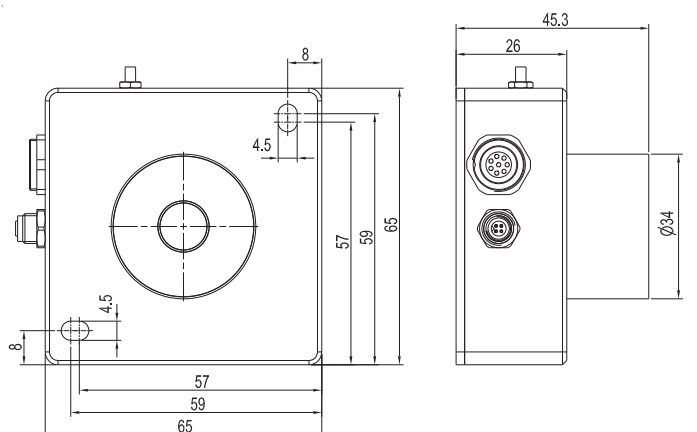

L-LAS Zubehör / Accessories

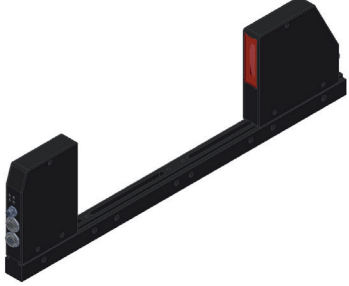

Befestigungsschienen für L-LAS-TB-...-CL (geteilte Versionen)

Mounting plates for L-LAS-TB-...-CL (split versions)

TYP	GEEIGNET FÜR SENSOR-SYSTEM (T+R)	ABSTAND SENDER/EMPFÄNGER	ABMESSUNGEN (CA.)	GEHÄUSEMATERIAL	ABB. ZEIGT BEFESTIGUNGSSCHIENE MIT SENSORSYSTEM
TYPE	SUITABLE FOR SENSOR SYSTEM (T+R)	DISTANCE TRANSMITTER/RECEIVER	DIMENSIONS (APPROX.)	HOUSING MATERIAL	ILLUSTR. SHOWS MOUNTING PLATE WITH SENSOR SYSTEM
TRA-L-LAS-TB-CL-L200	L-LAS-TB-6-T-CL + L-LAS-TB-6-R-CL L-LAS-TB-6-T-CL + L-LAS-TB-6-R-4/20-CL	Max. 60 mm	200 x 20 x 20 mm	Aluminium, schwarz eloxiert Aluminium, anodized in black	
	L-LAS-TB-16x1-T-CL + L-LAS-TB-16x1-R-CL L-LAS-TB-16x1-T-CL + L-LAS-TB-16x1-R-4/20-CL	Max. 60 mm			
	L-LAS-TB-1x16-T-CL + L-LAS-TB-1x16-R-CL L-LAS-TB-1x16-T-CL + L-LAS-TB-1x16-R-4/20-CL	Max. 60 mm			
TRA-L-LAS-TB-CL-L400	L-LAS-TB-6-T-CL + L-LAS-TB-6-R-CL L-LAS-TB-6-T-CL + L-LAS-TB-6-R-4/20-CL	Max. 260 mm	400 x 20 x 20 mm	Aluminium, schwarz eloxiert Aluminium, anodized in black	
	L-LAS-TB-16x1-T-CL + L-LAS-TB-16x1-R-CL L-LAS-TB-16x1-T-CL + L-LAS-TB-16x1-R-4/20-CL	Max. 260 mm			
	L-LAS-TB-1x16-T-CL + L-LAS-TB-1x16-R-CL L-LAS-TB-1x16-T-CL + L-LAS-TB-1x16-R-4/20-CL	Max. 260 mm			
	L-LAS-TB-28-T-CL + L-LAS-TB-28-R-CL L-LAS-TB-28-T-CL + L-LAS-TB-28-R-4/20-CL	Max. 222 mm			
	L-LAS-TB-50-T-CL + L-LAS-TB-50-R-CL L-LAS-TB-50-T-CL + L-LAS-TB-50-R-4/20-CL	Max. 205 mm			
	L-LAS-TB-75-T-CL + L-LAS-TB-75-R-CL L-LAS-TB-75-T-CL + L-LAS-TB-75-R-4/20-CL	Max. 200 mm			
	L-LAS-TB-100-T-CL + L-LAS-TB-100-R-CL L-LAS-TB-100-T-CL + L-LAS-TB-100-R-4/20-CL	Max. 160 mm			
TRA-L-LAS-TB-CL-L600	L-LAS-TB-6-T-CL + L-LAS-TB-6-R-CL L-LAS-TB-6-T-CL + L-LAS-TB-6-R-4/20-CL	Max. 460 mm	600 x 20 x 20 mm	Aluminium, schwarz eloxiert Aluminium, anodized in black	
	L-LAS-TB-16x1-T-CL + L-LAS-TB-16x1-R-CL L-LAS-TB-16x1-T-CL + L-LAS-TB-16x1-R-4/20-CL	Max. 460 mm			
	L-LAS-TB-1x16-T-CL + L-LAS-TB-1x16-R-CL L-LAS-TB-1x16-T-CL + L-LAS-TB-1x16-R-4/20-CL	Max. 460 mm			
	L-LAS-TB-28-T-CL + L-LAS-TB-28-R-CL L-LAS-TB-28-T-CL + L-LAS-TB-28-R-4/20-CL	Max. 222 mm			
	L-LAS-TB-50-T-CL + L-LAS-TB-50-R-CL L-LAS-TB-50-T-CL + L-LAS-TB-50-R-4/20-CL	Max. 205 mm			
	L-LAS-TB-75-T-CL + L-LAS-TB-75-R-CL L-LAS-TB-75-T-CL + L-LAS-TB-75-R-4/20-CL	Max. 200 mm			
	L-LAS-TB-100-T-CL + L-LAS-TB-100-R-CL L-LAS-TB-100-T-CL + L-LAS-TB-100-R-4/20-CL	Max. 160 mm			
	TRA-L-LAS-TB-CL-L800	L-LAS-TB-6-T-CL + L-LAS-TB-6-R-CL L-LAS-TB-6-T-CL + L-LAS-TB-6-R-4/20-CL			
L-LAS-TB-16x1-T-CL + L-LAS-TB-16x1-R-CL L-LAS-TB-16x1-T-CL + L-LAS-TB-16x1-R-4/20-CL		Max. 660 mm			
L-LAS-TB-1x16-T-CL + L-LAS-TB-1x16-R-CL L-LAS-TB-1x16-T-CL + L-LAS-TB-1x16-R-4/20-CL		Max. 660 mm			
L-LAS-TB-28-T-CL + L-LAS-TB-28-R-CL L-LAS-TB-28-T-CL + L-LAS-TB-28-R-4/20-CL		Max. 622 mm			
L-LAS-TB-50-T-CL + L-LAS-TB-50-R-CL L-LAS-TB-50-T-CL + L-LAS-TB-50-R-4/20-CL		Max. 605 mm			
L-LAS-TB-75-T-CL + L-LAS-TB-75-R-CL L-LAS-TB-75-T-CL + L-LAS-TB-75-R-4/20-CL		Max. 600 mm			
L-LAS-TB-100-T-CL + L-LAS-TB-100-R-CL L-LAS-TB-100-T-CL + L-LAS-TB-100-R-4/20-CL		Max. 560 mm			

Blasluftaufsätze für L-LAS-TB-...-CL (geteilte Versionen)

Blast air top parts for L-LAS-TB-...-CL (split versions)

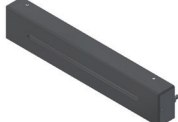
TYP	GEEIGNET FÜR SENSOR-TYP	ABMESSUNGEN (CA.)	GEHÄUSEMATERIAL	ABBILDUNG
TYPE	SUITABLE FOR SENSOR TYPE	DIMENSIONS (APPROX.)	HOUSING MATERIAL	ILLUSTRATION
ABL-TB-6-CL	L-LAS-TB-6-T-CL L-LAS-TB-6-R-CL L-LAS-TB-6-R-4/20-CL	83x30x18 mm	PVC schwarz PVC, black	
ABL-TB-16-CL	L-LAS-TB-16x1-T-CL L-LAS-TB-16x1-R-CL L-LAS-TB-16x1-R-4/20-CL	83x30x15 mm		
ABL-TB-28-CL	L-LAS-TB-28-T-CL L-LAS-TB-28-R-CL L-LAS-TB-28-R-4/20-CL	101x27x15 mm		
ABL-TB-50-CL	L-LAS-TB-50-T-CL L-LAS-TB-50-R-CL L-LAS-TB-50-R-4/20-CL	101x27x15 mm		
ABL-TB-75-CL	L-LAS-TB-75-T-CL L-LAS-TB-75-R-CL L-LAS-TB-75-R-4/20-CL	121x27x15 mm		
ABL-TB-100-CL	L-LAS-TB-100-T-CL L-LAS-TB-100-R-CL L-LAS-TB-100-R-4/20-CL	146x27x15 mm		

**Hersteller | Manufacturer**

Sensor Instruments Entwicklungs- und Vertriebs GmbH
Schlinging 11
D-94169 Thurmansbang/Germany
Telefon +49 (0) 8544.97 19-0
Telefax +49 (0) 8544.97 19-13
info@sensorinstruments.de
www.sensorinstruments.de

Vertriebspartner Deutschland | Distributors Germany

PLZ 10-19, 39
 Sensor Instruments
 Entwicklungs- und Vertriebs GmbH
 Schlinging 11
 94169 Thurmansbang
 Tel. +49 (0) 8544.97 19 0
 info@sensorinstruments.de
 www.sensorinstruments.de

PLZ 20-29, 30-32, 38, 49
 Pulsotronic GmbH & Co. KG
 Vertrieb Nord-West
 Waakhauser Straße 9
 28719 Bremen
 Tel. +49 (0) 421.64 26 44
 info@pulsotronic.de
 www.pulsotronic.de

PLZ 33, 40-48, 58-59
 ipf electronic gmbh
 Vertrieb Mitte
 Römerweg 25
 58513 Lüdenscheid
 Tel. +49 (0) 2351.4 10 32
 mitte@ipf.de
 www.ipf.de

PLZ 01-09, 34-37, 50-57,
 60-65, 67-69, 95, 96, 98, 99
 IMC Systemtechnik
 Kirchstraße 29
 64846 Groß-Zimmern
 Tel. +49 (0) 6071.748 65 72
 info@imc-systemtechnik.de
 www.imc-systemtechnik.de

PLZ 66, 70-79, 86-89,
 90, 91, 97
 [mu:v] GmbH
 Marcel-Breuer-Straße 15
 80807 München
 Tel. +49 (0) 89.28 77 85 70
 info@mu-v.de
 www.mu-v.de

PLZ 80-85, 92-94
 Sensor Instruments
 Entwicklungs- und Vertriebs GmbH
 Schlinging 11
 94169 Thurmansbang
 Tel. +49 (0) 8544.97 19 0
 info@sensorinstruments.de
 www.sensorinstruments.de

Vertriebspartner International | Distributors International

Kontakt Daten finden Sie unter www.sensorinstruments.de

For contact details please see www.sensorinstruments.de

