

FIO Series (Accessories)

▶ C-MOUNT-Q1-180°-50/50

Mounting bracket for transmitted light fiber optics with sensor head type D-S-Q1-...

- For mounting and optimum alignment of a transmitted light fiber optics type D-S-Q1-...
- Axial orientation of the two fiber optics heads: 180°
- Distance between transmitter and receiver: 50 mm
- Distance between beginning of measurement range (on the inside) and inner edge of cross member: 50 mm
- Fixation of the fiber optics by means of threaded screws
- Various mounting possibilities
- Sturdy aluminum housing, anodized in black

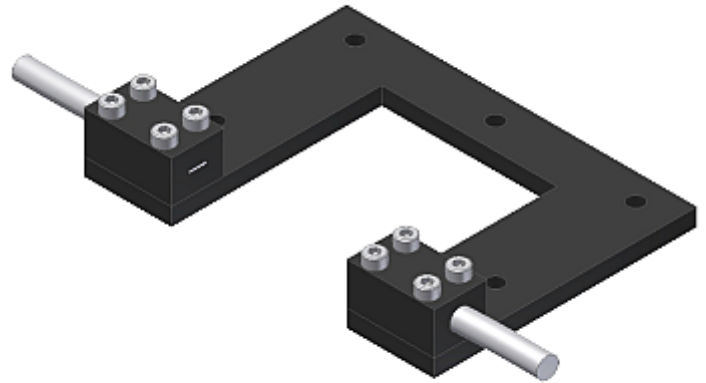

Design

Product name:

C-MOUNT-Q1-180°-50/50 (suitable for transmitted light fiber optics D-S-Q1-(5x0.5)-...-67°, width of measurement range: 5 mm)
(formerly: KL-50/50-5)

Please order fiber optics separately,
for further information see „FIO catalog“

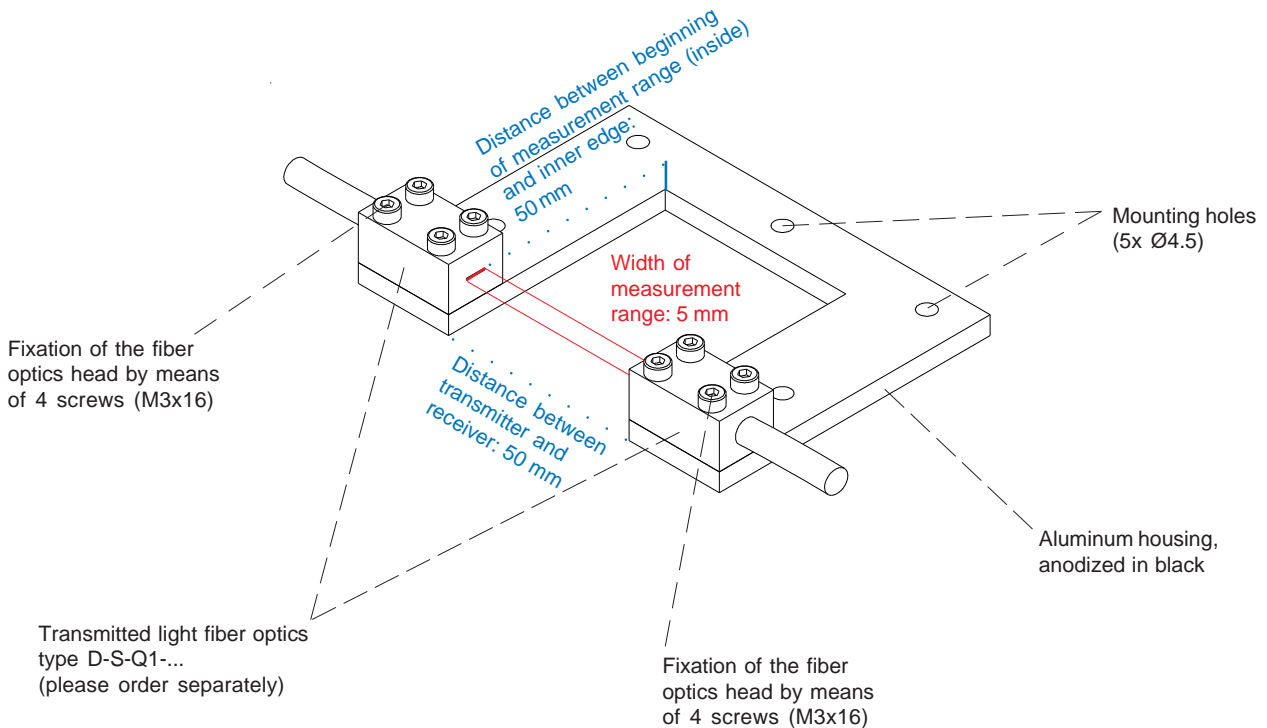



Dimensions

C-MOUNT-Q1-180°-50/50

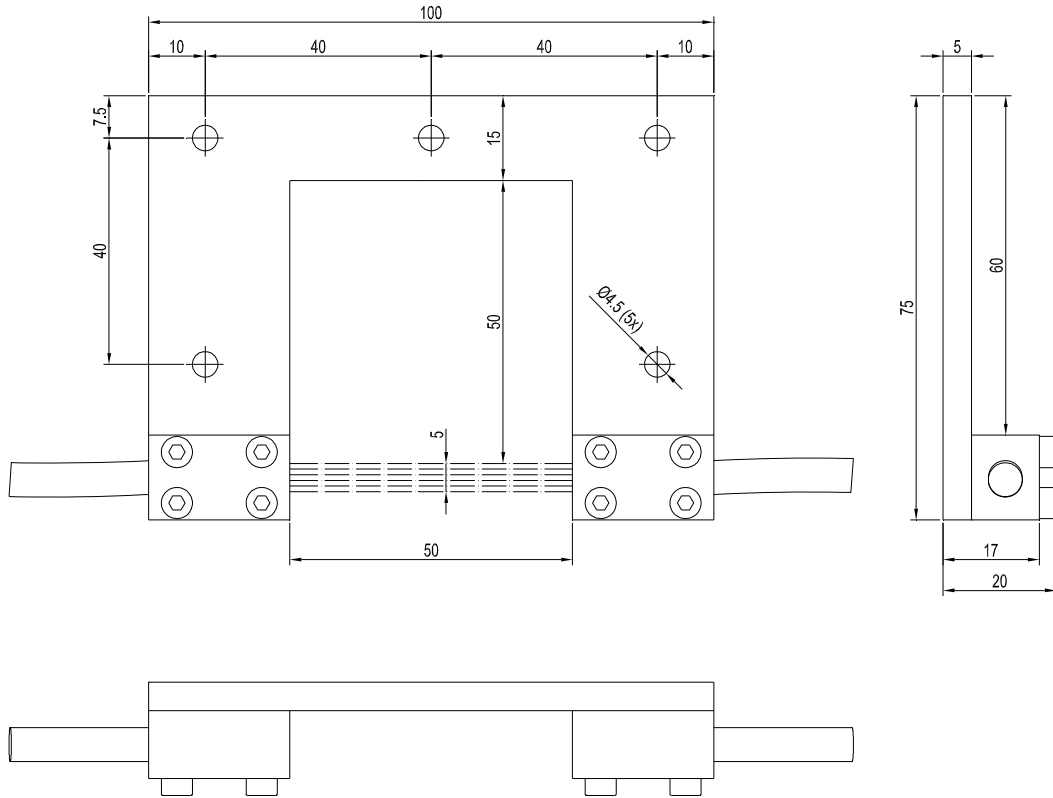

All dimensions in mm

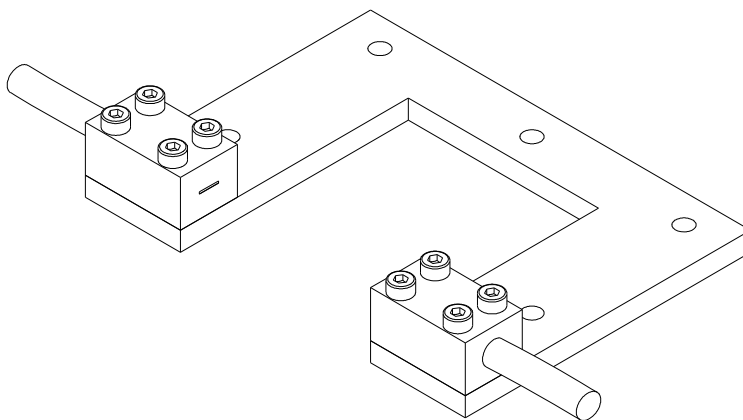



Variants

C-MOUNT-Q1-180°-50/50

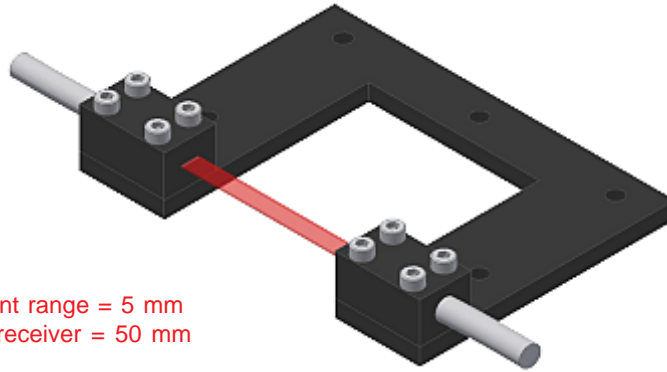

Width of measurement range = 5 mm
Distance transmitter/receiver = 50 mm

Fiber optics D-S-Q1-(5x0.5)-...-67°
(please order separately)

C-MOUNT-Q2-180°-50/50

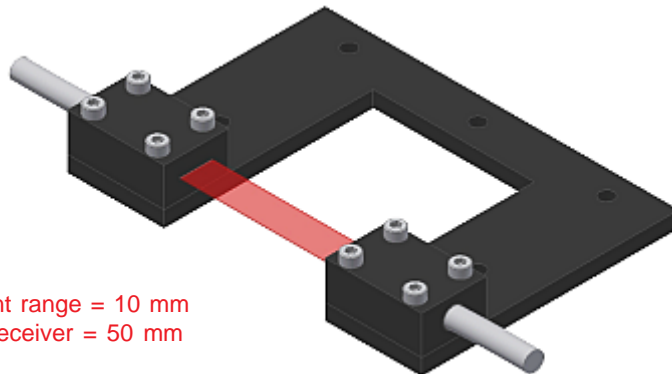

Width of measurement range = 10 mm
Distance transmitter/receiver = 50 mm

Fiber optics D-S-Q2-(10x0.3)-...-67°
(please order separately)

C-MOUNT-Q3-180°-50/50

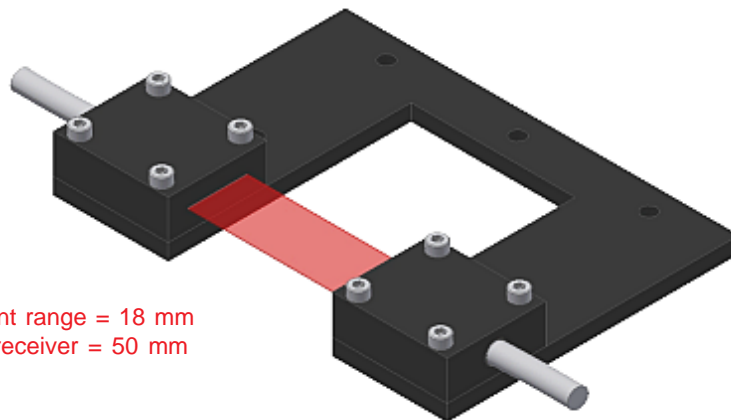

Width of measurement range = 18 mm
Distance transmitter/receiver = 50 mm

Fiber optics D-S-Q3-(18x0.3)-...-67°
(please order separately)



Variants

C-MOUNT-Q4-180°-50/50

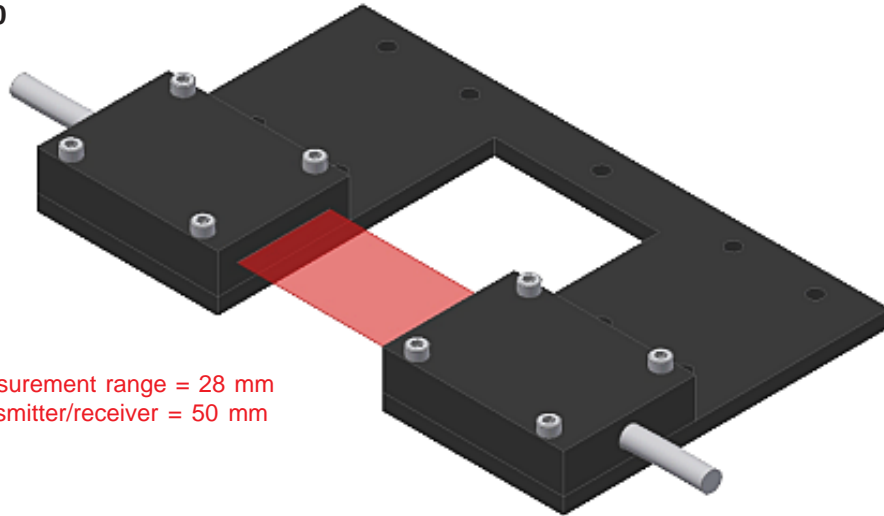

Width of measurement range = 28 mm
Distance transmitter/receiver = 50 mm

Fiber optics D-S-Q4-(28x0.2)-...-67°
(please order separately)

C-MOUNT-Q5-180°-50/50

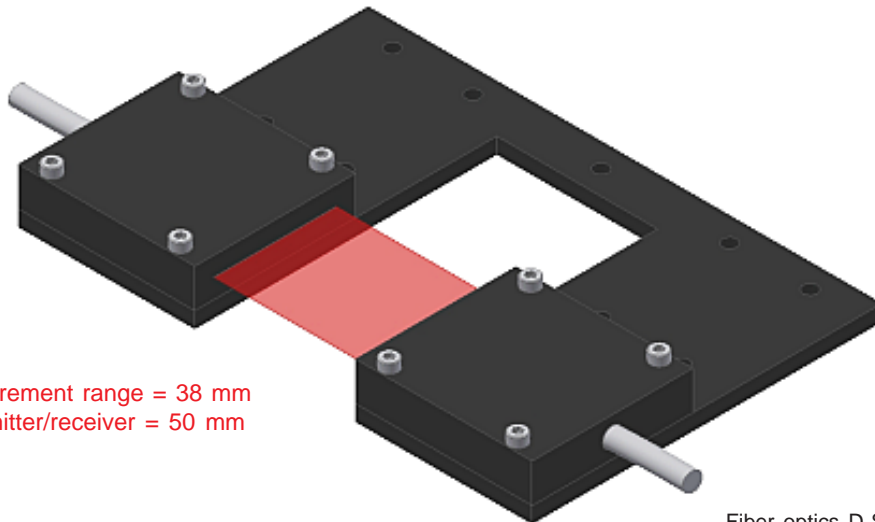

Width of measurement range = 38 mm
Distance transmitter/receiver = 50 mm

Fiber optics D-S-Q5-(38x0.15)-...-67°
(please order separately)

C-MOUNT-Q6-180°-50/50

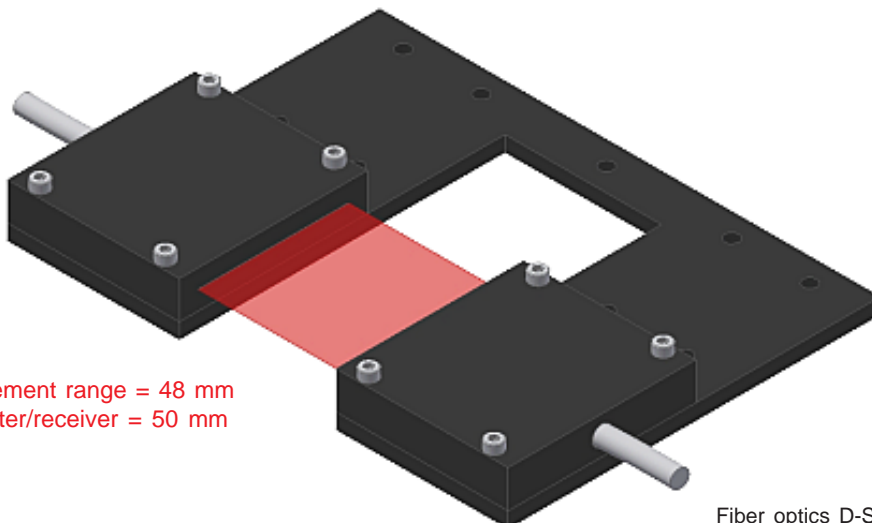

Width of measurement range = 48 mm
Distance transmitter/receiver = 50 mm

Fiber optics D-S-Q6-(48x0.15)-...-67°
(please order separately)