

SPECTRO-LAB Series

► SPECTRO-3-0°/45°-MSM-LAB-ANA-P

- **Color measurement** (Tristimulus Colorimeter) of plastic granulate, plastic recycle and plastic flakes
- L*a*b* measurement according to the 0°/45° method
- Calibration on site using RAL plastic cards
- High optical averaging due to large white light spot (typ. 20 mm in diameter)
- Windows® software SPECTRO3-MSM-DOCAL-Scope V1.0
- Up to 3 colors can be stored
- Averaging adjustable (from 1 to over 32000 values)
- Teaching of colors via panel PC
- Display of the current color value (L*a*b*) of a sample as well as its color deviation (dL*da*db* and dE) to the reference in the TEACH table
- Recording of the measurement results in a file to be created
- Readout of the created file by means of Excel and Word possible
- Graphical monitoring of the last 100 measurements dL*da*db* (trend)
- Creation and printing of a label
- 3 USB interfaces
- 1 Ethernet interface
- +24V power supply
- Panel PC integrated
- Stainless steel housing
- Interactive operation of the software (both during calibration and measurement)



Design

Product name:

SPECTRO-3-28-0°/45°-MSM-LAB-ANA-P

(incl. Windows® software SPECTRO3-MSM-DOCAL-Scope V1.0)

Accessories: (page 10+11)

Calibration cards
Pellet sample containers and recycles
Label printer
Keyboard
Mouse

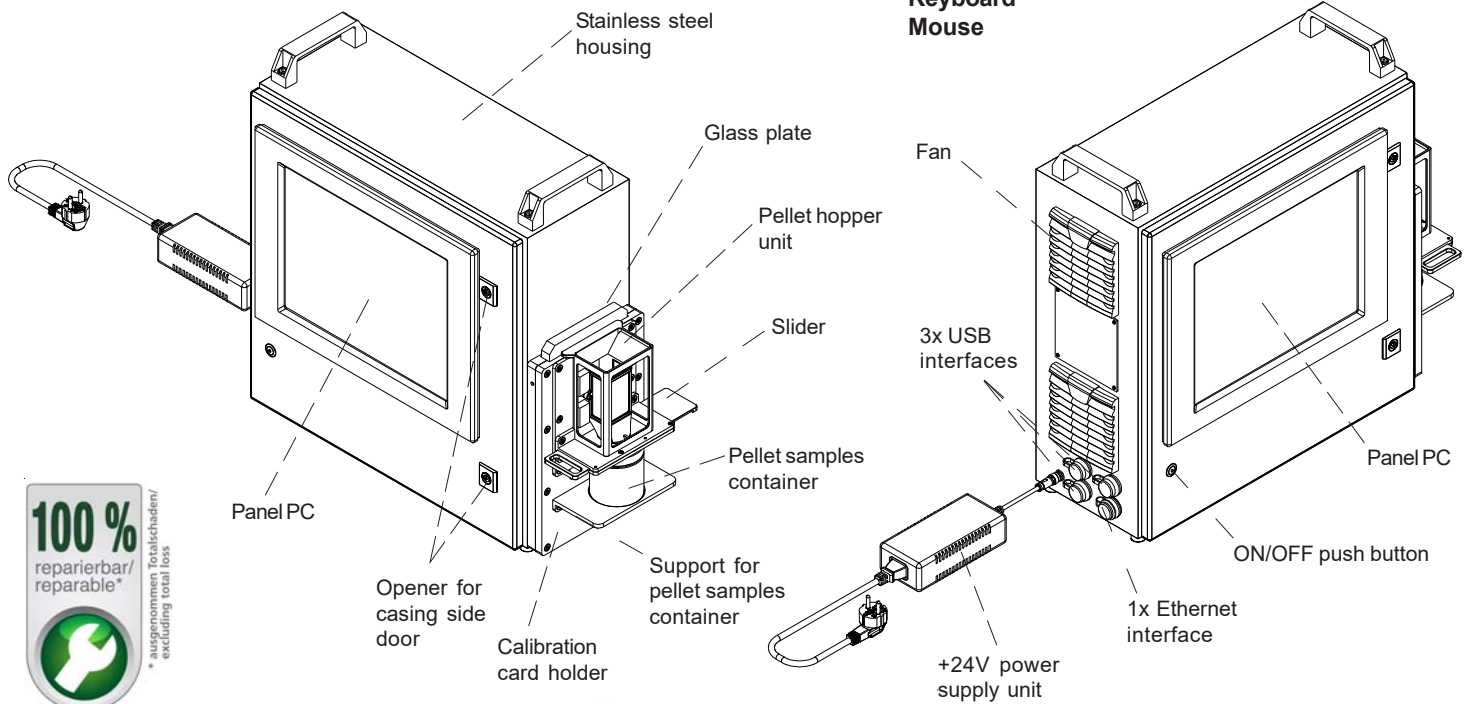

Sensor
Instruments



Technical Data

Type	SPECTRO-3-0°/45°-MSM-LAB-ANA-P
Voltage supply	+24VDC (± 10%), reverse polarity protected, overcurrent protected
Current consumption	< 1A
Max. switching current (int.)	100 mA, short circuit proof
Input digital (1x) (internal)	IN0 (Pin 3), digital (0V/+24V)
Outputs digital (2x) (int.)	OUT0, OUT1 (Pin 4 and 5): digital (0V/+24V), npn-/pnp-able (bright-/dark-switching, can be switched)
Outputs analog (3x) (int.)	OUT2, OUT3, OUT4 (Pin 6, 7, and 8): 0...+10V or 4...20mA (xyY, a*b*L*; u*v*L*, u'v'L*, C*h*L*, XYZ)
Interface	3x USB, 1x ETHERNET, RS232 (internal)
Pulse lengthening (internal)	0 ... 100 ms, adjustable via PC software
Averaging	max. 32768 values, adjustable via PC software
Scan frequency (internal) (alternating light mode/ direct light mode)	LED operation, can be switched via PC software: AC operation: max. 25 kHz (depends on parameterization) DC operation: max. 90 kHz (depends on parameterization)
Switching frequency (int.)	typ. 60 kHz
Analog band width (int.)	max. 90 kHz (-3dB)
Transmitter (light source)	LED with spectral characteristics similar to D65
Transmitter control (internal)	can be switched via PC software: AC operation (LED MODE-AC), DC operation (LED MODE-DC)
Object distance (internal) (measuring range)	typ. 85 mm
Receiver	3-color filter detector (TRUE COLOR detector, "human color perception"), color filter curves acc. to CIE 1931
Receiver gain setting (int.)	8 steps (AMP1 ... AMP8), adjustable via PC software
Ambient light	max. 5000 Lux
Size of light spot	typ. 20 mm in diameter, at 85 mm distance from the sensor frontend
Reproducibility	in the X, Y color range each 1 digit at 12-bit A/D conversion
Temperature drift X,Y	$\Delta X/\Delta T$; $\Delta Y/\Delta T$ typ. 0,2 digits/°C (< 0,01% / °C)
Measuring accuracy	typ. $\Delta E = 0.3$
Resolution	$\Delta E \geq 0.01$
Color space	CIE L*a*b*
Color memory capacity	non-volatile EEPROM with parameter sets for max. 3 colors
Housing dimensions	LxWxH approx. 612.2 mm x 225 mm x 557 mm
Housing material	stainless steel housing, attachments in black anodized aluminum
Enclosure rating	IP54
Connecting cables	standard Ethernet and USB ports
Type of connector	standard Ethernet and USB sockets
Operating temp. range	-20°C ... +55°C
Storage temperature range	-20°C ... +85°C
EMC test acc. to	DIN EN 60947-5-2



Dimensions

SPECTRO-3-0°/45°-MSM-LAB-ANA-P

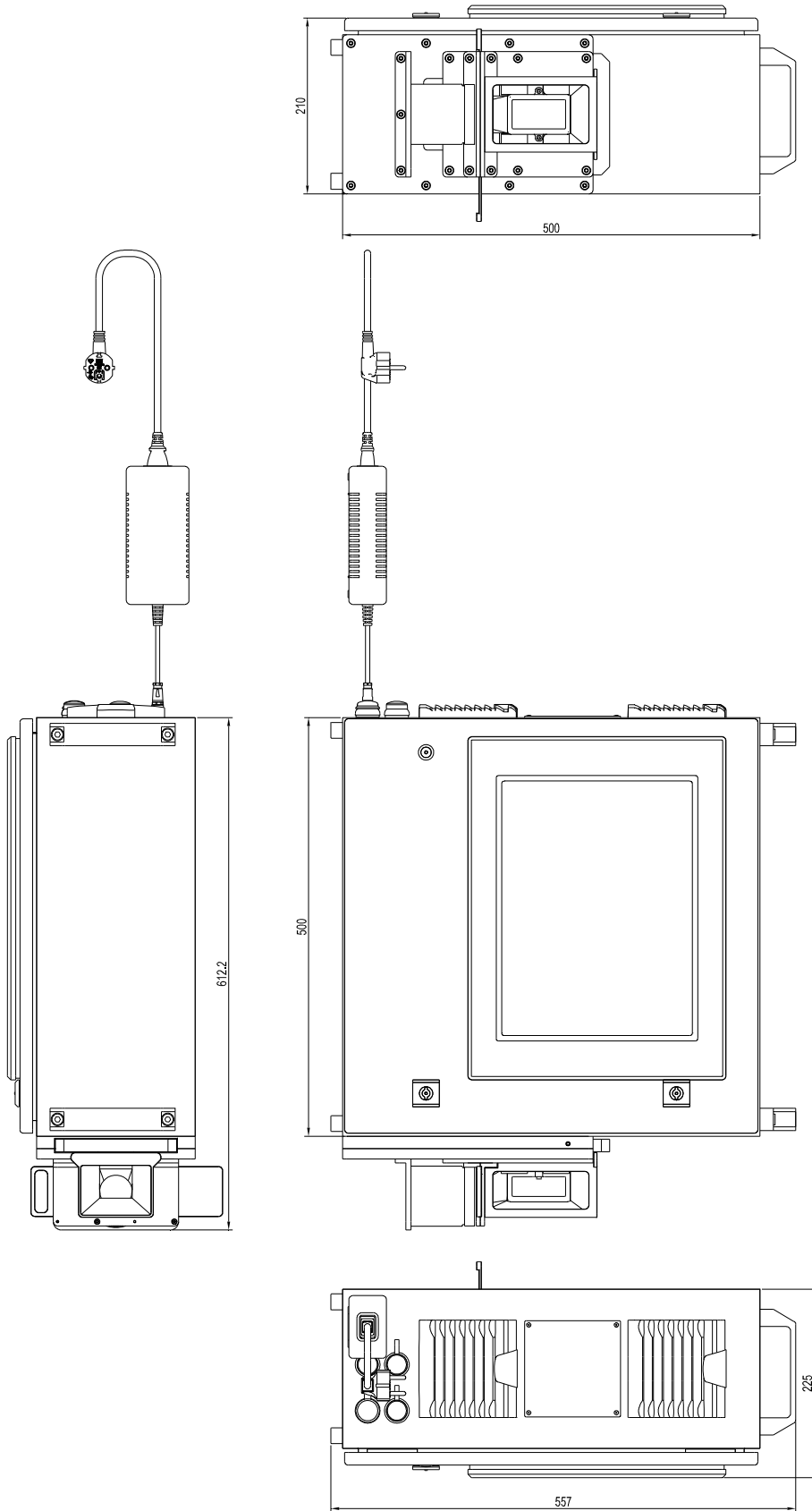

All dimensions in mm

**Measuring Principle****The measuring principle**

The so-called 0° /45° method is used as the basis for color measurement, whereby the recycle sample is illuminated under 0° and observed under 45°. The recycle is placed behind a glass plate during the measurement, so the distance from the sensor head to the recycle is constant. A recycle surface with a diameter of approx. 20mm is illuminated and observed, thus a sufficiently high optical averaging is achieved, whereby the slightly differing position of the pellets from measurement to measurement no longer has any noticeable influence on the measurement result.

Two components essentially make up the measuring system; the first is the actual evaluation unit, with integrated microprocessor, electronics including optoelectronics, and electrical and optomechanical interface. The second is the optical frontend, which is connected to the evaluation unit via two optical fiber strands.

The color measurement system has an RS232 interface, the color evaluation unit is connected to a panel PC integrated in the system via an RS232/USB converter. By means of a hopper unit, the plastic recycle is placed as tightly packed as possible in front of the 15mm thick glass pane separating the interior from the exterior.

After the measurement has been completed, the plastic recycle is filled back into the empty sample container by pulling the mechanical slide.

RAL plastic cards are used to calibrate the measuring system. Care should be taken to ensure that the colors of the plastic cards used correspond approximately to those of the pellet samples. For this purpose, the pellet hopper is removed from the measuring system and the calibration cards (RAL plastic cards) can then be inserted one after the other into the opening provided for this purpose.

Using SPECTR03-MSM-DOCAL-Scope V1.0 software, the operator of the measuring system is guided through the calibration process.

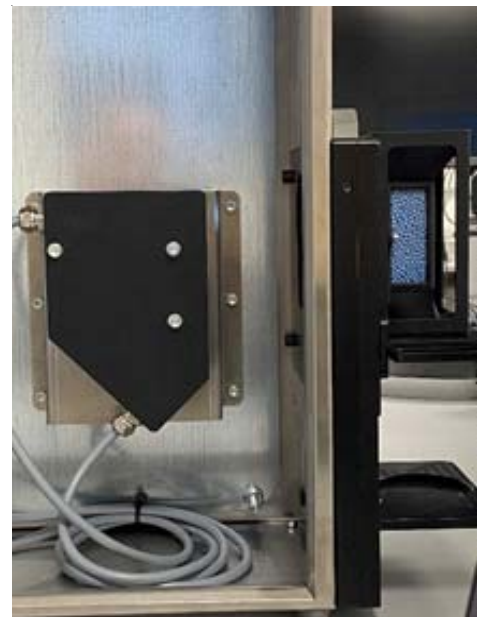



Measuring System

The measuring system SPECTRO-3-0°/45°-MSM-LAB-ANA-P

The SPECTRO-3-0°/45°-MSM-LAB-ANA-P laboratory color measurement system essentially consists of the following components:



Evaluation unit incl. sensors, panel PC, keyboard, mouse, USB interfaces, calibration card holder, support for pellet samples container, pellet hopper with sight glass, slider

Calibration card holder, support for pellet samples container, pellet hopper with sight glass, slider



Label printer



Calibration cards



Pellet samples container



Pellet hopper with sight glass



Calibration

Calibration of the evaluation unit

Before measurement can begin, the color evaluation unit must first be calibrated. Calibration is performed with the aid of RAL plastic cards.

In addition to the calibration to a white plastic card, the so-called white balance, for example with the help of the RAL plastic card RAL9003-P, RAL plastic cards should be used for calibration, if possible, which visually resemble the recyclates to be examined in terms of color.

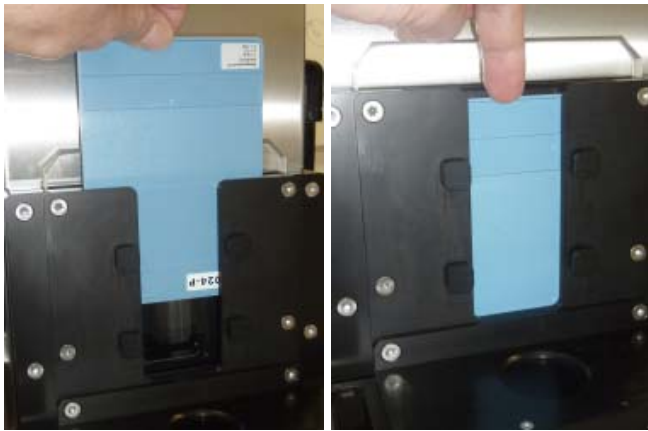

By means of the Windows® software SPECTRO3-MSM-DOCAL-Scope, the user is guided through the calibration process and requested to enter the names of the respective RAL plastic cards into the software fields provided for this purpose on the screen and furthermore to insert the respective calibration card into the opening provided for this purpose in the calibration card holder unit.

This procedure must be repeated for all the RAL plastic cards provided. It is not necessary to repeat the calibration procedure before each measurement, but it is advisable to perform a calibration procedure extended by these calibration cards after adding further recyclate samples whose colors are not yet covered by the calibration cards in use.



Measuring Procedure

Color measurement of recyclate samples

After successful calibration, the pellet hopper unit must still be flanged onto the calibration card holder unit for color measurement of plastic recyclates.

First of all, the RAL plastic card that may still be present in the calibration card holder unit must be removed. After opening the pellet sample container, pour the pellets completely into the pellet hopper unit and place the empty sample container below it in the recess provided for this purpose.



In the following pastel blue recyclate samples are to be measured in terms of color. These samples are similar to the RAL plastic card RAL5024-P, which was also used for calibration of the laboratory color measurement system.

The calibration card does not necessarily have to match the recyclate sample exactly in color, but the accuracy of the measuring system is increased if RAL plastic cards are used for calibration which are at least close in color to the recycled samples.

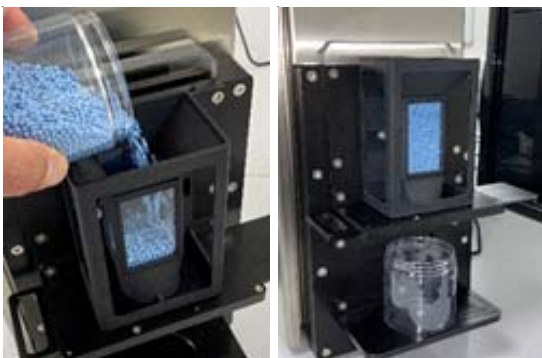

In the next step, the pellets are completely filled from the sample container into the pellet hopper unit. After the plastic recyclate is now in position, the actual measuring process can be started.

For this purpose, the tab TEACH is called up in the Windows® software SPECTR03-MSM-DOCAL-Scope V1.0. The $L^*a^*b^*$ color values of the plastic pellet sample can now be stored in the TEACH table (after clicking the „TEACH DATA TO“ software button).

In the case of the pastel blue recyclate sample, the color value is $L^* = 61.69$, $a^* = -7.22$, $b^* = -20.24$.

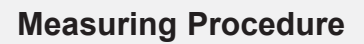

Windows® user interface

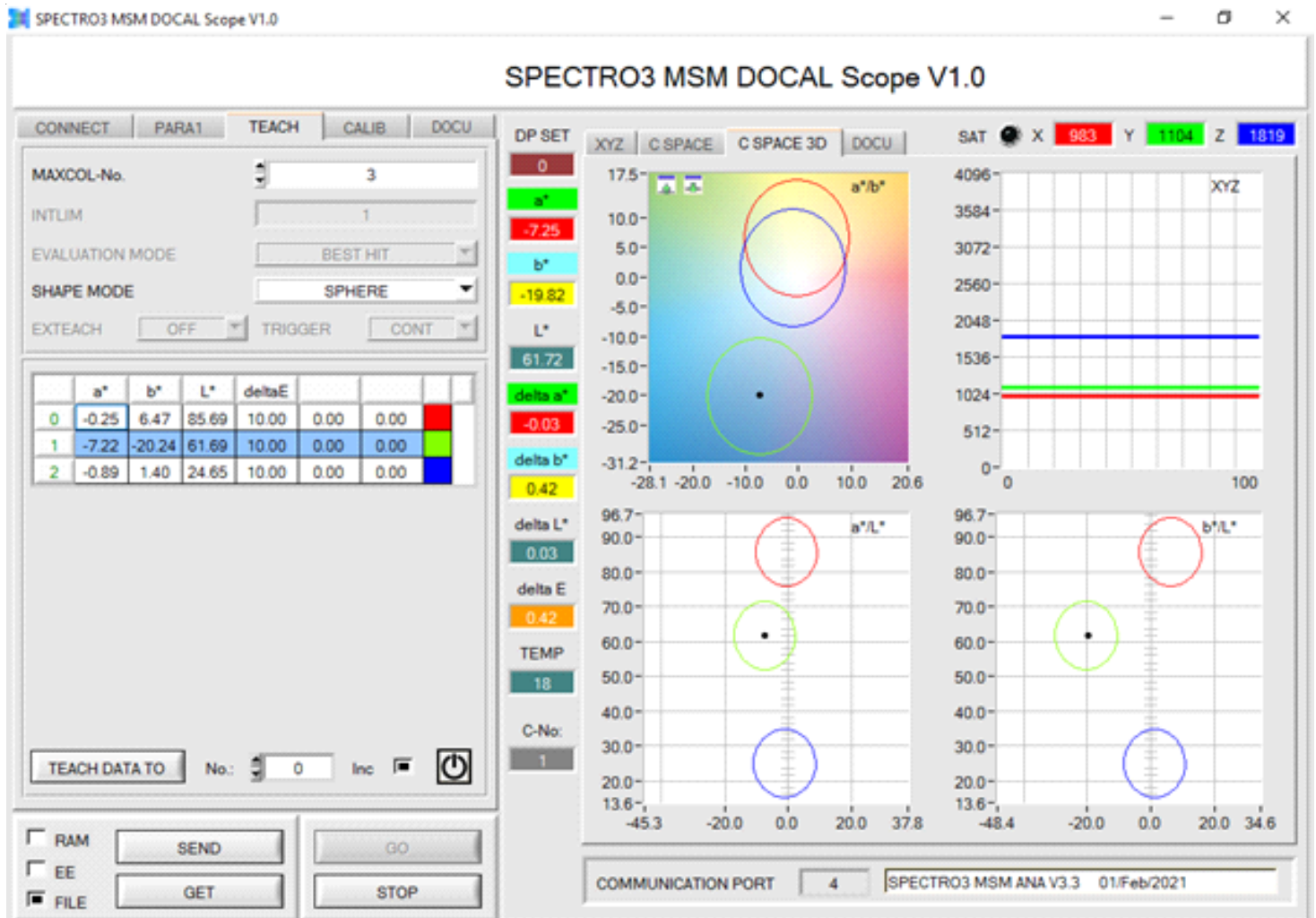

Windows® user interface SPECTRO3-MSM-DOCAL-Scope V1.0, tab TEACH

In addition to the current $L^*a^*b^*$ color values, the software now also displays the da^* , db^* and dl^* color deviations from the taught reference. Additionally, the total color deviation in the color space dE is displayed numerically.

The graphs show the position of the current color value and the taught references (from the TEACH table) from three different angles (a^*b^* , a^*L^* and b^*L^*).

Switching to the tab DOCU brings us to the Windows® interface, where the individual measurements can be seen and furthermore the labels as well as the files for storing the color values can be created.



Measuring Procedure



Windows® user interface: SPECTRO3-MSM-DOCAL-Scope V1.0, tab DOCU

In the right section of the Windows® interface, the last 100 measurements are displayed, rather the deviations in L^* , a^* and b^* to the entered reference in the TEACH table, thus the dL^* , da^* and db^* values. In the left section of the Windows® interface, a file can be defined in which the measurement data are to be stored. Furthermore, the label inscription can be specified. This is done by line 1 and optionally line 2. However, line 2 can also be used to output the current date and time. The label will be created by clicking the „PRINT DOCUMENTATION DATA“ button.





Accessories

The Calibration Cards

RAL plastic cards are used as calibration cards. Since these were measured at the factory (RAL gemeinnützige GmbH, Bonn) according to the $d/8^\circ$ method (diffusely illuminated and viewed below 8° to the normal), whereas the color sensor system used in the laboratory color measurement system is based on the $0^\circ/45^\circ$ measurement method, the available RAL cards from Sensor Instruments were re-measured according to the $45^\circ/0^\circ$ method by means of a calibrated hand-held device; the corresponding $L^*a^*b^*$ values were attached by means of labels to the respective cards as well as card covers.

In addition, a file was created, thereby an assignment of the RAL numbers was made with regard to the matching $L^*a^*b^*$ color values.



Pellet sample container and recyclates

For the respective recyclates to be tested, pellet sample containers are available which have been selected in terms of their dimensions so that they both fit into the recess provided in the calibration card holder unit and, in addition, the amount of recyclate matches the volume of the pellet hopper unit.



For calibration of the color measurement system it is recommended to use RAL plastic cards, which visually resemble the respective recyclate samples in color.

**Accessories****The label printer**

A printer of type „cab eos2“ is used as label printer.



The label printer is preset at the factory so that the interface driver, the label format and the label roll are suitable for this application.

The connection to the laboratory device is established via a USB interface cable.

