

A-LAS Series

▶ A-LAS-10-...-C

- Analog signal (0...+10V) in connection with an electronic control unit type AGL4, AGL4-HS, AGL-DIF, SI-CON11 (without PC connection) or SI-CON8, SI-CON34, A-LAS-CON1 (with PC connection and software) (stand-alone operation of the light barrier is not possible)
- Parallel aligned, visible red laser beam (<0.39 mW, 670 nm), **laser class 1**
- Various apertures available
- Measuring range up to 4mm (depends on aperture used)
- Working range max. 10 m (depends on aperture used)
- Insensitive to outside light due to interference filter
- Compact design, sturdy metal housing, IP67

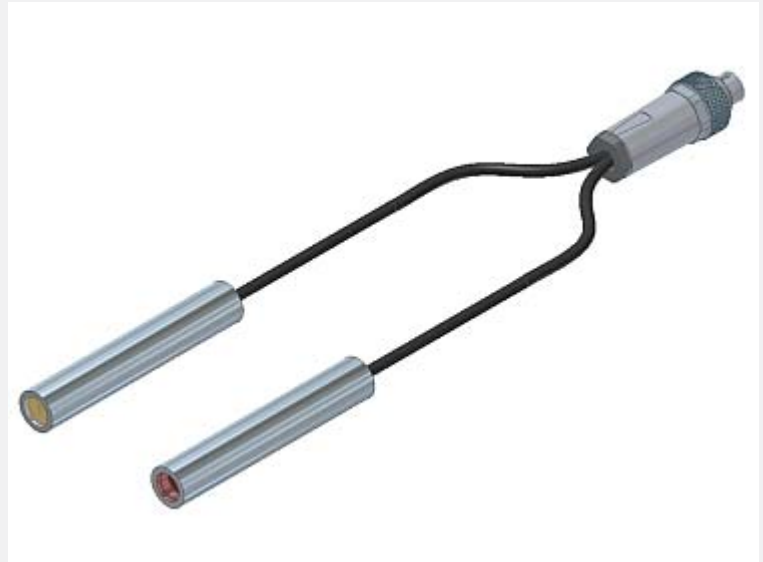

Design

Product name:

A-LAS-10-(aperture)*-C-(cable length)**

(consists of transmitter and receiver, incl. cable with 7-pole circular connector 712)

Accessories: (cf. page 3)

MOUNT-LS10
MOUNT-LS10/2
(Mounting angles)

*Available apertures:

Rectangular apertures

AxB (mm):	
0.2x0.5	(= 0.5x0.2)
0.2x1	(= 1x0.2)
0.3x0.5	(= 0.5x0.3)
0.3x1	(= 1x0.3)
0.3x1.5	(= 1.5x0.3)
0.3x3	(= 3x0.3)
0.5x1	(= 1x0.5)
0.5x3	(= 3x0.5)
0.5x4	(= 4x0.5)
0.75x2	(= 2x0.75)
0.75x3	(= 3x0.75)
1x1	
1x2	(= 2x1)
1x4	(= 4x1)
2x1.2	(= 1.2x2)
2x3	(= 3x2)

Round apertures

d... (mm):
d0.3
d0.5
d0.7
d1.0
d2.0

****Available cable lengths:** 1m, 2m, 3m, 5m
(transmitter and receiver with same cable length)

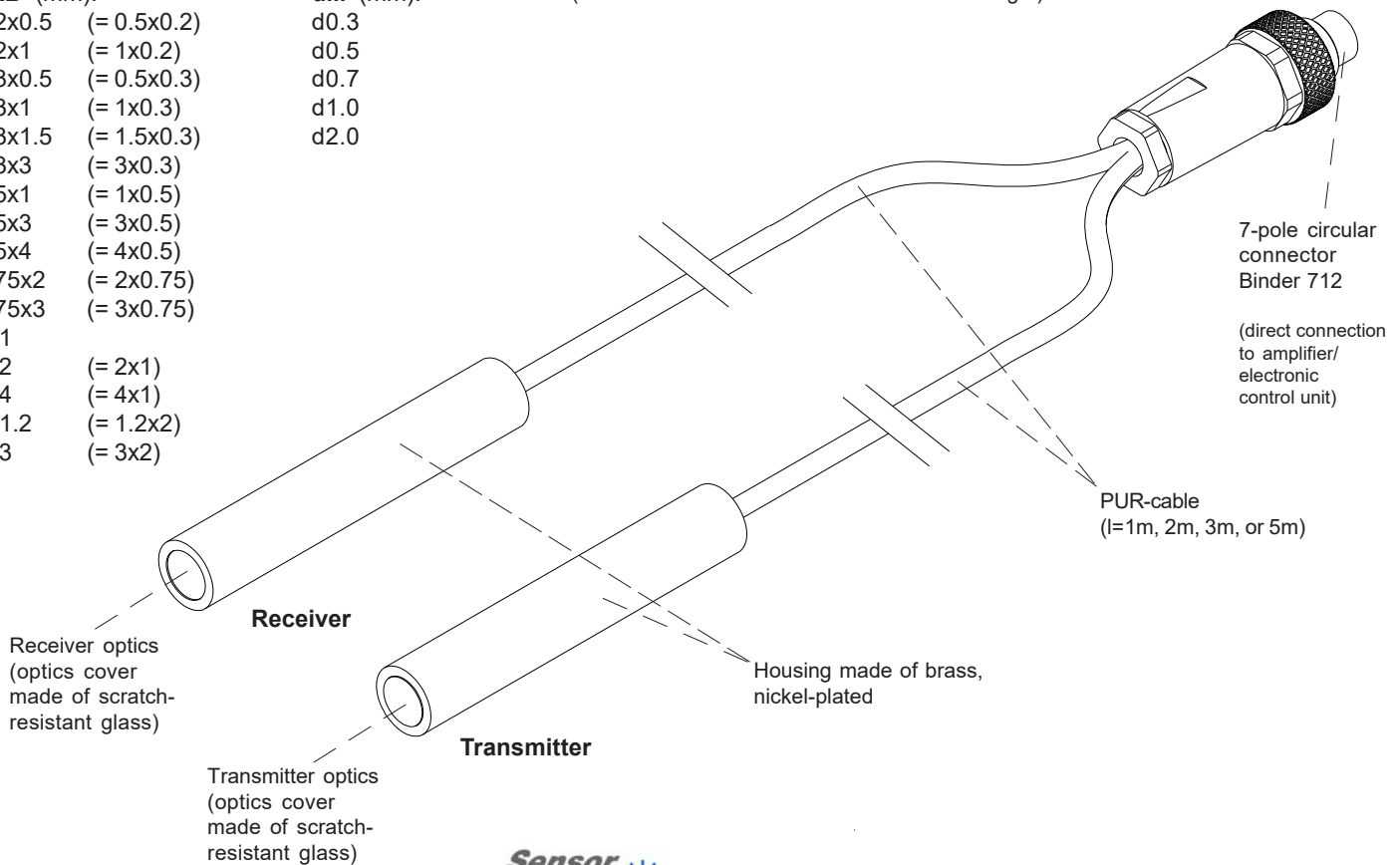



Technical Data

Type	A-LAS-10
Shape	Laser light barrier in cylindrical shape. Various round or rectangular apertures are available.
Laser	Solid-state laser, 670 nm, DC-operation, 0.39 mW max. opt. power, laser class 1 acc. to DIN EN 60825-1. The use of these laser transmitter therefore requires no additional protective measures.
Available aperture sizes	Cf. page 1
Measuring range	Up to 4 mm (depends on the aperture used)
Working range	Max. 10 m (depends on the aperture used)
Min. detectable object	Typ. 1% of aperture size
Reproducibility	Typ. 1% of aperture size, with threshold correction (via electronic control unit): typ. 0.1% of aperture size
Threshold correction	Can be activated via a software-controlled electronics of type A-LAS-CON1, SI-CON4, SI-CON8, or SI-CON34
Optical filters	Red light filter RG 630 and interference filter
Voltage supply	Transmitter: +5VDC, receiver: +5VDC
Ambient light (outside light)	With 5000 Lux ambient light around optical receiver unit typ. < 300mV influence on analog signal (0...+10V)
Analog output	0 ... +10V (in connection with any electronic control unit of A-LAS Series)
Band width analog signal	100 kHz (-3 dB)
Current control input (I-CONTROL)	0V ... 5V, laser power decreases linear to increase of voltage: 0V: full power, 5V: laser off
Sensitivity setting (switching threshold)	Via software (with control electronics A-LAS-CON1, SI-CON4, SI-CON34, or SI-CON8) or via potentiometer (with control electronics AGL4 or AGL4-HS)
Gain (analog signal)	Via software (with control electronics A-LAS-CON1, SI-CON4, SI-CON34, or SI-CON8) or via potentiometer (with control electronics AGL4, AGL4-HS, AGL-DIF, or SI-CON11)
Current consumption	Transmitter: typ. 50 mA, receiver typ. 20 mA
Operating temperature range	0°C ... +50°C
Storage temperature range	-20°C ... +85°C
Type of connector	Transmitter: 3-pole M8-connector, receiver: 4-pole M8-connector
Housing material	Brass, nickel-plated
Housing dimensions	Transmitter and receiver: each LxØ approx. 58 mm x Ø 10 mm (without connector M8)
Enclosure rating	IP67
EMC test acc. to	DIN EN 60947-5-2 



Laser Information

The laser transmitters of A-LAS series comply with laser class 1 according to EN 60825-1. Under reasonably foreseeable conditions a class 1 laser is safe. The reasonably foreseeable conditions are kept during specified normal operation. The use of these laser transmitters therefore requires no additional protective measures.

The laser transmitters of A-LAS series series are supplied with an information label „CLASS 1 Laser Product“.

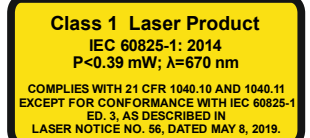

Dimensions

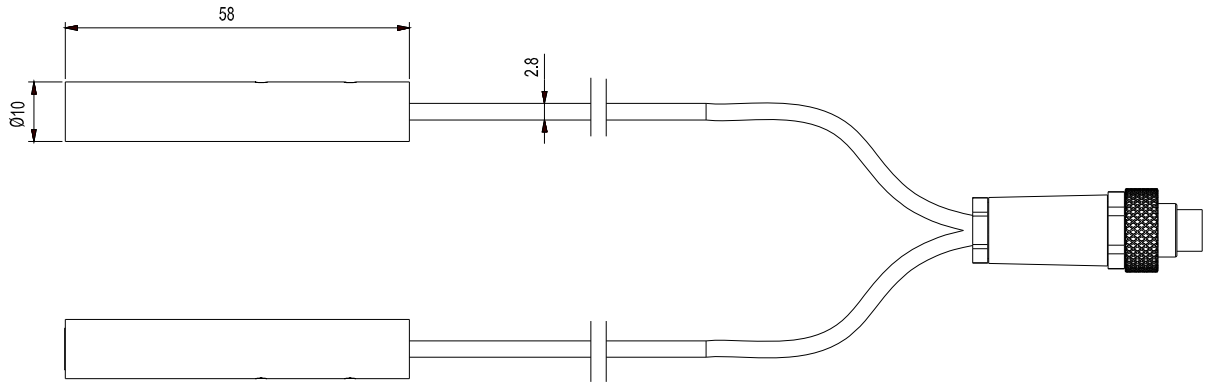

All dimensions in mm

Connector Assignment

7-pole circular connector Binder Series 712:

Pin-No.:	Assignment:
1	0V (GND)
2	+5V
3	I-CONTROL (0V...+5V)
4	+5V
5	ANALOG
6	n.c.
7	0V (GND)

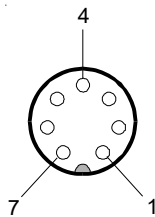

Connection directly to an electronic control unit from A-LAS Series: AGL4, AGL4-HS, AGL-DIF, SI-CON11, SI-CON8, SI-CON34, A-LAS-CON1

Mounting Accessories

Mounting angle for A-LAS-10-C-... (suitable for transmitter and receiver): (please order separately)

MOUNT-LS10
(aluminum, anodized)

MOUNT-LS10/2
(aluminum, anodized)

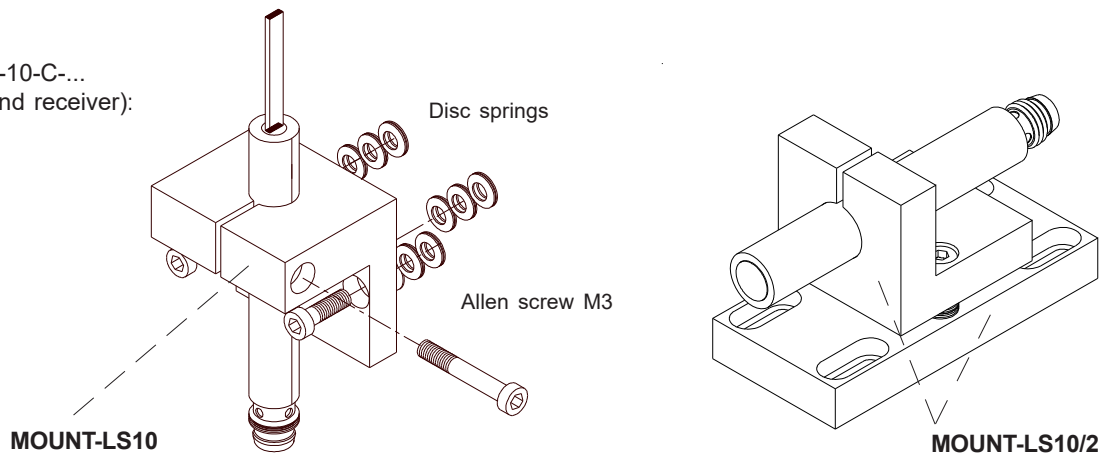



Electronic Control Units

Suitable electronic control units for A-LAS-...-C:

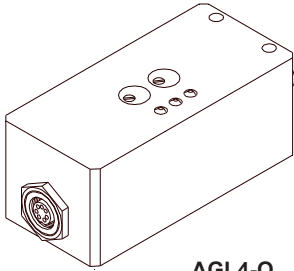

AGL4-Q
AGL4-Qinv
AGL4-Qinv-200ms

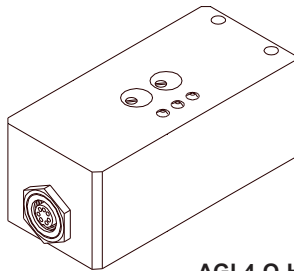

AGL4-Q-HS-500kHz-24V_LED
AGL4-Qinv-HS-500kHz-24V_LED

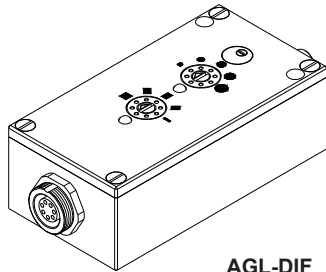

AGL-DIF

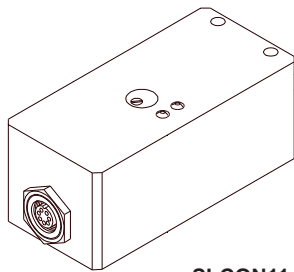

SI-CON11-0/20
SI-CON11-0/20-5V
SI-CON11-0/20-IC
SI-CON11-4/20
SI-CON11-4/20-IC
SI-CON11-5/25
SI-CON11-5/25-IC

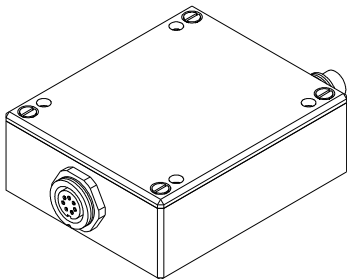

SI-CON8
(incl. Windows® PC software
SI-CON8-Scope)

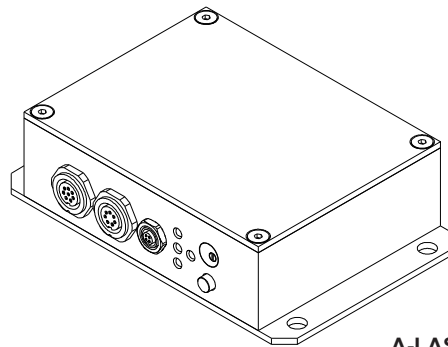

A-LAS-CON1
(incl. Windows® PC software
A-LAS-CON1-Scope)

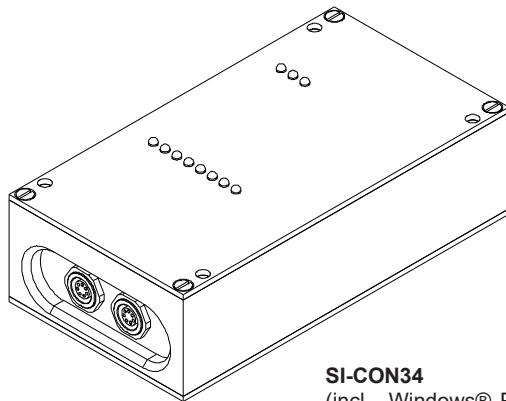

SI-CON34
(incl. Windows® PC software
SCOPE34)

